



# RVC 2-33 CDplus

## with infrared heating

part no. 100244



Rotational Vacuum  
Concentrator

# Operating Manual

Please retain for later use!



In case of inquiries, please state the following numbers:

Order number:

Serial number:

© Copyright by  
Martin Christ Gefriertrocknungsanlagen GmbH  
An der Unteren Söse 50  
37520 Osterode am Harz  
Germany  
Tel.: +49 (0) 5522 / 5007-0  
Fax: +49 (0) 5522 / 5007-12  
Web: [www.martinchrist.de](http://www.martinchrist.de)  
E-mail: [info@martinchrist.de](mailto:info@martinchrist.de)



---

<b>1</b>	<b>General information</b> .....	<b>9</b>
1.1	Importance of the operating manual.....	9
1.2	Intended use.....	9
1.3	Warranty and liability.....	11
1.4	Copyright.....	12
1.5	Explanation of symbols.....	12
1.6	Standards and regulations.....	12
1.7	Scope of supply.....	12
<b>2</b>	<b>Layout and mode of operation</b> .....	<b>13</b>
2.1	Layout of the RVC.....	13
2.1.1	Functional and operating elements.....	13
2.1.2	Name plate.....	14
2.2	Mode of operation.....	15
2.2.1	Principle of the rotational vacuum concentration.....	15
2.2.1.1	Advantages of the rotational vacuum concentration.....	16
2.2.1.2	Examples of use.....	16
<b>3</b>	<b>Safety</b> .....	<b>17</b>
3.1	Marking of the unit.....	17
3.2	Explanation of the symbols and notes.....	18
3.3	Responsibility of the operator.....	19
3.4	Requirements concerning the personnel.....	20
3.5	Informal safety instructions.....	21
3.6	Safety notes concerning the transport, set-up and connection and initial start-up of the freeze-dryer.....	22
3.6.1	General hazards.....	22
3.6.2	Hazards caused by improper transport.....	22
3.6.3	Hazards caused by improper set-up.....	22
3.6.4	Hazards caused by an improper connection.....	23
3.7	Safety notes concerning the operation.....	23
3.7.1	Electrical safety.....	24
3.7.2	Hazards through the lid.....	24
3.7.3	Hazards due to damaged accessories.....	24
3.7.4	Hazards due to hot surfaces.....	25
3.7.5	Hazards due to flammable and explosive substances.....	25
3.7.6	Hazards caused by harmful products.....	25
3.7.7	Hazards caused by contaminated condensate (defrosting water).....	26
3.7.8	Safety instructions for evaporation.....	26
3.7.9	Hazards due to the evaporation of harmful precursors.....	27
3.8	Safety devices.....	28
3.8.1	System check.....	28
3.8.2	Power failure safety.....	28
3.8.3	Lid lock device.....	28
3.8.4	Earth conductor check.....	28

## Table of contents

3.9	Procedures in the event of hazards and accidents.....	29
3.10	Maintenance and cleaning of the rotational vacuum concentrator.....	30
3.11	Measures to ensure the safe operation of the rotational vacuum concentrator.....	31
3.12	Remaining hazards.....	32
<b>4</b>	<b>Storage and transport .....</b>	<b>33</b>
4.1	Storage conditions .....	33
4.2	Dimensions and weight.....	33
4.3	Packaging.....	33
4.4	Transport safety device.....	34
4.5	On-site transport.....	34
<b>5</b>	<b>Set-up and connection .....</b>	<b>35</b>
5.1	Installation site .....	35
5.2	Power supply .....	35
5.2.1	Type of connection .....	35
5.2.2	Customer-provided fuses.....	35
5.3	Aeration and air injection valve (valve block) .....	36
5.4	Vacuum connections.....	37
5.5	Option: Pressure control valve and vacuum sensor .....	38
5.6	Connection of a vacuum pump and/or a cooling trap .....	39
5.6.1	Withdrawal of the vapours by a vacuum pump.....	39
5.6.2	Condensation of the vapours upstream of the vacuum pump in a cooling trap.....	40
5.6.2.1	Option: Remote control of the FD cooling trap via RVC.....	41
<b>6</b>	<b>Operation.....</b>	<b>42</b>
6.1	Initial start-up .....	42
6.2	Switching the RVC on.....	42
6.3	Opening and closing the lid.....	42
6.4	Installation of rotors and accessories .....	43
6.4.1	Installation of angle rotors.....	43
6.4.2	Installation of swing-out rotors .....	44
6.4.3	Installation of accessories.....	44
6.4.3.1	Tubes.....	45
6.4.3.2	Rotor blocks.....	46
6.4.3.3	Buckets.....	46
6.5	CDplus control system .....	48
6.5.1	User interface .....	48
6.5.2	Mode .....	51
6.5.3	Main menu.....	53
6.5.3.1	Changing the set values for the manual mode .....	53
6.5.3.2	Program administration .....	55
6.5.3.3	Special functions.....	58
6.5.3.4	Process and equipment information.....	59
6.5.3.5	Options .....	60

**Table of contents**

---

<b>7</b>	<b>Malfunctions and error correction</b> .....	<b>63</b>
7.1	General malfunctions .....	63
7.1.1	Error messages .....	63
7.1.2	Process messages .....	64
7.1.3	System messages .....	65
7.1.4	Emergency lid release system .....	65
7.1.5	Small flange connections .....	72
7.2	Service contact .....	73
<b>8</b>	<b>Maintenance and service</b> .....	<b>74</b>
8.1	Maintenance .....	74
8.1.1	General.....	74
8.1.2	Rotor chamber.....	76
8.1.3	Accessories .....	80
8.1.3.1	Aluminium accessories .....	80
8.1.4	Glass breakage .....	81
8.2	Disinfection of the rotor chamber and accessories.....	81
8.3	Autoclaving.....	82
8.4	Service .....	82
8.5	Return of defective parts.....	83
<b>9</b>	<b>Disposal</b> .....	<b>85</b>
9.1	Disposal of the RVC.....	85
9.2	Disposal of the packaging.....	85
<b>10</b>	<b>Technical data</b> .....	<b>86</b>
10.1	Ambient conditions .....	87
10.2	Technical documentation .....	87
<b>11</b>	<b>Appendix</b> .....	<b>88</b>
11.1	Mathematical relations .....	88
11.2	Rotor program.....	89
11.3	Overview of evaporation times (RVC 2-33 CDplus with infrared heating).....	90
11.4	Brief operating instructions .....	92
11.5	EC declaration of conformity .....	95
11.6	Declaration of conformity – China RoHS 2.....	97
<b>12</b>	<b>Glossary</b> .....	<b>99</b>
<b>13</b>	<b>Index</b> .....	<b>101</b>

**Table of contents**

---



## 1 General information

### 1.1 Importance of the operating manual

A fundamental requirement for the safe and trouble-free operation of the unit is to be familiar with the fundamental safety instructions and all possible hazards.

The operating manual includes important information concerning the safe operation of the rotational vacuum concentrator (RVC).

This operating manual, and in particular the notes on safety and hazards, must be observed by all persons operating the unit.

In addition, the local rules and regulations for the prevention of accidents must be complied with.

### 1.2 Intended use

CHRIST rotational vacuum concentrators are solely intended for evaporation under rotation and vacuum. Possible areas of application include:

- Concentration of DNA/RNA, proteins, etc.
- Sample preparation for HPLC/thin-layer chromatography, gas chromatography and mass spectroscopy
- Isolation/synthesis of natural substances
- High-throughput screening (HTS)
- General evaporation tasks in laboratories

Any other use beyond this area of application is regarded as improper use. Martin Christ Gefriertrocknungsanlagen GmbH cannot be held liable for any damage resulting from such improper use.

#### **Evaporation of solvent-containing products (non-aqueous media)**

In terms of the corrosion resistance, the use of organic solvents in aqueous solutions is acceptable.

By design, rotational vacuum concentrators are chemically resistant against most compounds that are typically used. However, by necessity, rotational vacuum concentrators comprise several different materials, some of which may be attacked and degraded by certain chemicals.

The manufacturing methods and/or conditions of exposure of the materials, as well as the way the chemicals are applied, can influence the results. Some of these factors are listed below:

- Manufacturing: Stress generated while sawing, sanding, machining, drilling, polishing and/or forming.
- Exposure: Length of exposure, stresses induced during the service life due to various loads (changes in temperature, etc.).
- Application of chemicals: by contact, rubbing, wiping, spraying, etc.

## 1 General information

With the exception of hydrochloric acid, nearly all standard solvents can be used. For further details, see the table below.

Solvent	Stainless steel	Aluminium	EPDM	PPS	Borosilicate glass	Experience
Acetic acid 20%	+	+	o	+	+	?
Formic acid	o	o	-	o	+	?
Trifluoroacetic acid (TFA)	+	+	+	+	+	?
Acetone	+	+	o	+	+	?
Acetonitrile	+	+	o	+	+	+
Cyclohexane	+	+	-	+	+	?
Dioxane	+	+	o	+	+	+
Dimethylformamide	+	+	o	+	+	?
Dimethyl sulfoxide	+	+	+	+	+	+
Dichloromethane	+	+	-	o	+	-
Ethanol	+	+	+	+	+	+
Isopropyl alcohol	+	+	+	+	+	?
Methanol	+	+	+	+	+	+
tert-Butanol	+	+	o	+	+	?
Toluene	+	+	-	o	+	+
Tetrahydrofuran	+	+	-	o	+	?
Pyridine	+	+	o	+	+	?

Legend:

- + No degradation to be expected
- o Moderate degradation; limited use
- Severe degradation; infrequent use recommended; immediate thorough cleaning required

Damage to the rotational vacuum concentrator and its accessories due to chemicals can be significantly reduced by cleaning immediately after the end of the programme. All parts of the rotational vacuum concentrator that have come into contact with the product must be checked regularly for signs of damage and replaced, if necessary.



Solvents not included in the above table must not be used.

**Evaporation of solvent-containing products**

Evaporation of acid-containing products (with the exception of the substances listed under "Evaporation of solvent-containing products" with the concentration levels mentioned therein) is only permissible if special protective measures and equipment-related precautions are taken. Otherwise, there is a risk of damage to property and personal injury. Consultation of Martin Christ Gefriertrocknungsanlagen GmbH is absolutely mandatory in order to define the measures that need to be taken!

The intended use also includes:

- Observation of all of the notes and instructions that are included in the operating manual
- Compliance with the inspection and maintenance instructions

The following operations are regarded as **NOT PERMISSIBLE**:

- Use of the rotational vacuum concentrator if it is not properly installed.
- Use of the rotational vacuum concentrator if it is not in a perfect technical state.
- Use of the rotational vacuum concentrator within hazardous locations with an explosive atmosphere.
- Use of the rotational vacuum concentrator with unauthorised additions or conversions without the written approval by Martin Christ Gefriertrocknungsanlagen GmbH.
- Use of the rotational vacuum concentrator with accessories that have not been approved by Martin Christ Gefriertrocknungsanlagen GmbH, with the exception of commercially available vessels made of glass or plastic.
- Evaporation of products that may react during the evaporation process following the supply of high amounts of energy.
- Evaporation of azide-containing products.
- Evaporation of products that may damage the material of the chamber walls, rotor/rotor hub, pipes or seals, or that may affect the mechanical strength.

### 1.3 Warranty and liability

The warranty and liability are subject to our "General Terms and Conditions" that were distributed to the operator upon the conclusion of the contract.

Warranty and liability claims are excluded if they are due to one or several of the following reasons:

- improper use
- non-compliance with the safety instructions and hazard warnings in the operating manual
- improper installation, start-up, operation, and maintenance of the RVC.

## 1 General information

---

### 1.4 Copyright

The copyright concerning the operating manual remains with Martin Christ Gefriertrocknungsanlagen GmbH.

The operating manual is solely intended for the operator and their personnel. It includes instructions and information that may not be

- duplicated,
- distributed, or
- communicated in any other way neither in full nor in parts.

Non-compliance may be prosecuted under criminal law.

### 1.5 Explanation of symbols

In this operating manual, the specialist terms that are explained in the glossary (see chapter 12 - "Glossary") are marked by an arrow and printed in italics (e.g. → *safety pressure*).

### 1.6 Standards and regulations

EC-Declaration of conformity (see appendix)

### 1.7 Scope of supply

**The scope of supply comprises:**

- 1 hexagon socket wrench, size 5
- 1 L-key Torx® TX15
- 1 screwdriver Torx® TX8
- 1 operating manual

**Accessories and commissioning**

According to your order, our order confirmation, and our delivery note.

## 2 Layout and mode of operation

### 2.1 Layout of the RVC

#### 2.1.1 Functional and operating elements

- 1 Lid
- 2 Rotor chamber
- 3 Control panel (see chapter 6.5.1 - "User interface")
- 4 Lid lock device
- 5 Rotor shaft
- 6 Mains power switch
- 7 Electrical vacuum sensor connection
- 8 Option: Serial Interface RS 232
- 9 Option: Serial Interface Remote
- 10 Valve block (see chapter 5.3 - "Aeration and air injection valve (valve block)")
- 11 Power supply connection of the vacuum pump
- 12 Power supply connection of the pressure control valve
- 13 Name plate (see chapter 2.1.2 - "Name plate")
- 14 Vacuum connection
- 15 Equipotential bonding screw
- 16 Mains connection and mains fuse protection
- 17 Power supply connection of the stop valve



Fig. 1: Total view of the RVC



Fig. 2: Rear view of the RVC

## 2 Layout and mode of operation

### 2.1.2 Name plate

- 1 Serial number
- 2 Type
- 3 Nominal voltage
- 4 Year of manufacture (month/year)
- 5 Part number
- 6 Rated current / apparent power

CE  CHRIST				
1	Serial No.	00000	08/2021	4
2	RVC 2-33 CDplus IR		101244	5
	cool. system	1. stage	2. stage	
	refrigerant			
	filling			
	max. pressure			
3	230 V / 50/60 Hz		2.5 A / 0.6 kVA	6
D-37520 Osterode am Harz, An der Unteren Söse 50, Germany				

Fig. 3: Example of a name plate

## 2.2 Mode of operation

### 2.2.1 Principle of the rotational vacuum concentration

This method is used for the particularly quick and gentle evaporation, drying, purification, and concentration of samples.

Rotational vacuum concentration is an alternative to rotary evaporators that use high temperatures and operate nearly at normal pressure. Because of the vacuum, the sample boils at low temperatures, and water as well as organic solvents can be evaporated in a particularly gentle manner. Due to the fact that the sample rotates like in a centrifuge, the → *Boiling retardation* is prevented so efficiently that low pressure can be used. As a result, temperature-sensitive samples can be concentrated by evaporation without being damaged.

The solvent can be collected in a cooling trap and disposed of immediately if desired.

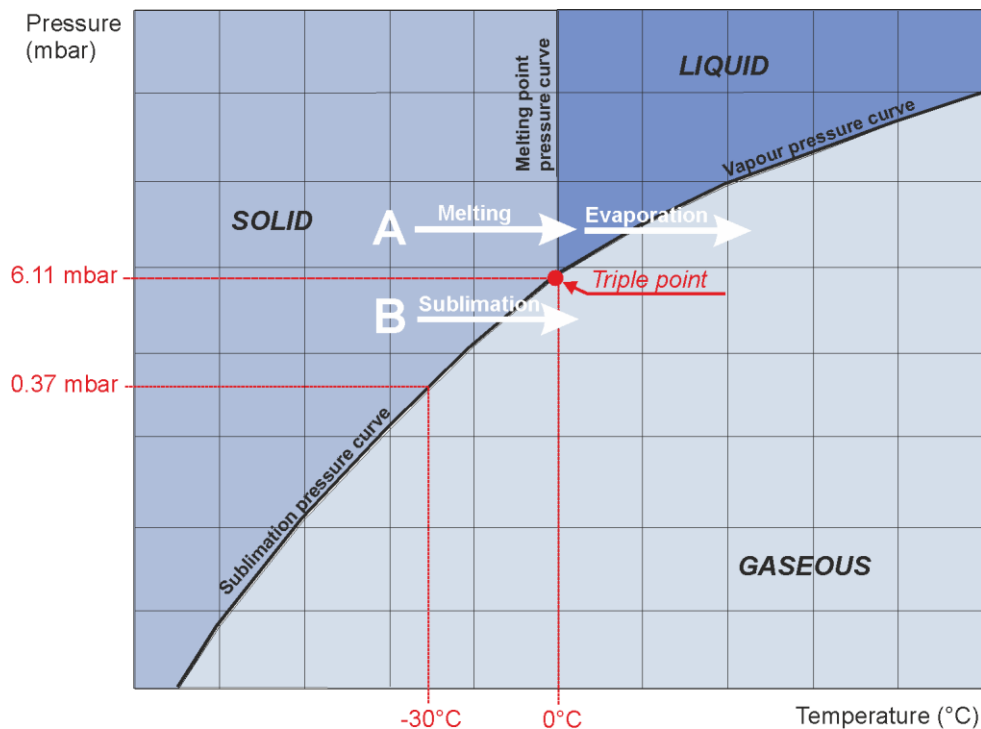

Fig. 4: Vapour pressure curve for ice and water

## 2 Layout and mode of operation

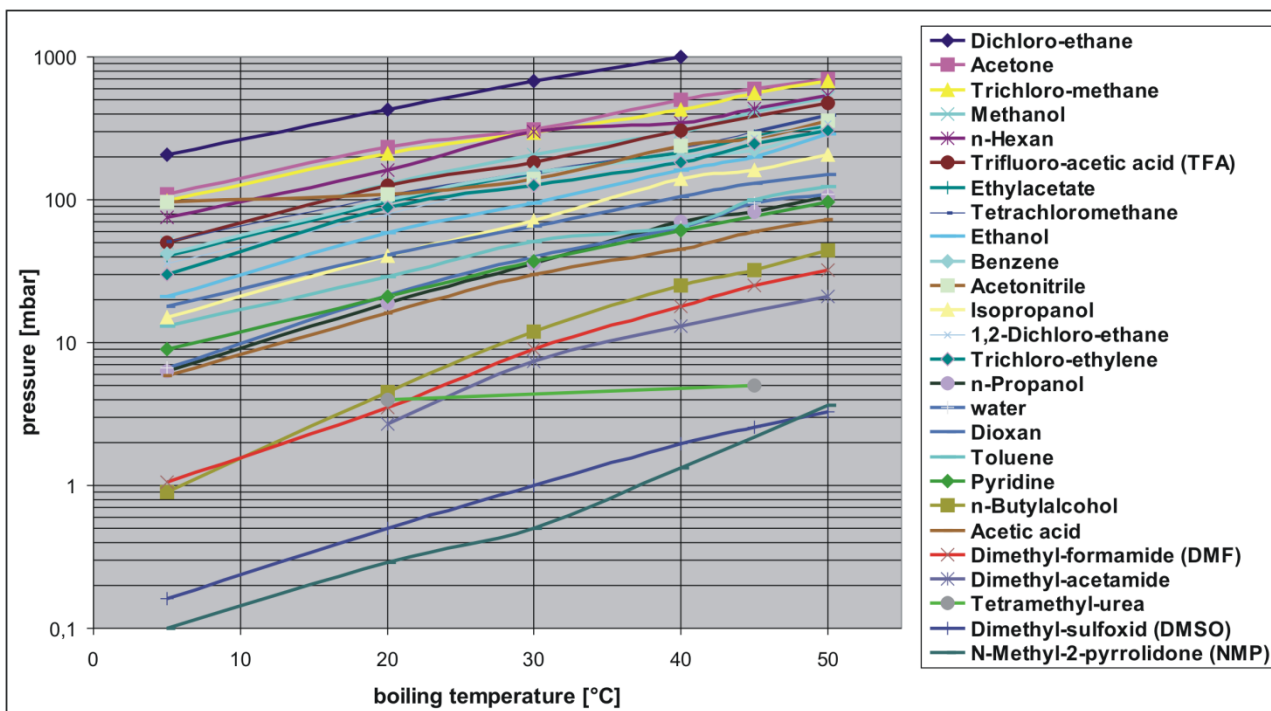

Fig. 5: Vapour pressure curves of commonly used organic solvents

### 2.2.1.1 Advantages of the rotational vacuum concentration

- No foaming of the samples, minimum loss.
- Several samples can be dried simultaneously.
- Concentration of the sample on the bottom of the vessel. This is particularly advantageous for small volumes or dilute solutions.
- Suitable for drying aqueous and solvent-containing samples.
- For volumes < 1 ml up to > 3 l.
- Reproducible drying processes thanks to controlled process parameters, such as the rotor chamber temperature (energy input for the evaporation) and vacuum (up to the automatic adjustment of the optimum operating pressure – depending on the pump systems).
- Easy and safe solvent recovery.

### 2.2.1.2 Examples of use











- DNA/RNA (mainly water, ethanol, or methanol as solvent)
- Oligo-synthesis, peptides
- PCR (polymer chain reaction)
- HPLC (mainly water/acetonitrile as solvent)
- Isolation/synthesis of organic substances
- Storage and handling of substances (substance libraries)
- Combinational chemistry
- High-throughput-screening (HTS)
- Analysis of food and environmental samples, toxicology
- Forensic applications
- General laboratory evaporation



### 3 Safety

#### 3.1 Marking of the unit

The following symbols are used for Christ RVC:

	Dangerous voltage	<b>I</b>	On (Power)
	Hot surface	<b>0</b>	Off (Power)
	Caution! Risk of bruising		Name plate (see chapter 2.1.2 - "Name plate")
	Attention, consult the operating manual	<b>CE</b>	CE mark in compliance with the directive 2006/42/EC
	Protective earth (ground)		Unplug the mains plug
	Earth (ground)		China RoHS 2 mark (only for China)
	Arrow indicating the direction of rotation		

**i**  
NOTE

Safety indications on the rotational vacuum concentrator must be kept readable at all times. If necessary, they must be replaced.

**i**  
NOTE

Not all of the symbols/labels are used for this RVC type.

### 3 Safety

## 3.2 Explanation of the symbols and notes

This operating manual uses the following names and symbols to indicate hazards:



**DANGER**

This symbol stands for a **direct** hazard to the life and health of persons. Non-observance of these symbols **causes** serious health problems up to life-endangering injuries.



**DANGER**

This symbol stands for a **direct** hazard to the life and health of persons due to electrical voltage. Non-observance of these symbols **causes** serious health problems up to life-endangering injuries.



**WARNING**

This symbol stands for a **potential** hazard to the life and health of persons. Non-observance of these symbols **can** cause serious health problems up to life-endangering injuries.



**CAUTION**

This symbol indicates a potentially hazardous situation. Non-observance of these notes can cause minor injuries or damage to property.



**NOTE**

This symbol indicates important information.

### 3.3 Responsibility of the operator

#### Operating personnel

The operator is obliged to ensure that the persons working on/with the rotational vacuum concentrator

- has been specially commissioned by the operator for this purpose and has received instruction on the hazards emanating from the device, the output and end products as well as on the behaviour to be adopted in the event of accidents and malfunctions and the measures to be taken in such cases,
- are familiar with the fundamental health, safety and accident prevention regulations,
- have been trained in terms of the operation of this system,
- have read and understood this operating manual (in particular the safety sections and warning notes) and confirmed this with their signature.
  - the rotor chamber up to the pressure control valve, aeration and micro-injection valve block
  - the glass lid
  - the vacuum measurement technology.

The areas of responsibility of the personnel concerning the operation, maintenance and care of the unit must be clearly defined.

The safety-conscious work of the personnel in compliance with the operating manual and the relevant EC health and safety directives and the national laws concerning health and safety and the prevention of accidents must be checked at regular intervals (e.g. every month).

#### Working area

The operator must

- perform a risk assessment concerning potential accidents in connection with the rotational vacuum concentrator and take design-related countermeasures, if necessary.
- Perform a risk assessment in view of the specific hazards associated with the processing of the respective product in the rotational vacuum concentrator (e.g. ignition/explosion hazard, leakage of harmful product residues at the outlets of the chamber) and take the corresponding measures, if necessary.
- perform a compatibility test of all substances that are used in the rotational vacuum concentrator (both products to be dried and cleaning agents, etc.) that come into contact with chamber walls, pipes and seals. The use of substances that damage the material (stainless steel 1.4404 and 1.4435, aluminium, borosilicate glass, EPDM and PPS) or weaken the mechanical strength is prohibited.
- have the system maintained at regular intervals (see chapter 3.4 - "Requirements concerning the personnel").
- Any parts or components that are not in perfect working order must be replaced without delay.

### 3 Safety

#### Additional points concerning the evaporation of solvent-containing products

With regards of corrosion resistance, the use of some organic solvents in aqueous solutions is acceptable.

Under certain circumstances, the evaporation of products containing solvents may lead to the formation of explosive mixtures. This is why the operator must draw up special operating instructions/SOPs including precise instructions

- concerning the chamber pressure and temperature for every product that is to be processed in the RVC,
- concerning the inspection of the RVC in view of damage caused by the solvent that is used (see chapter 1.2 - "Intended use", section "Evaporation of solvent-containing products").

### 3.4 Requirements concerning the personnel



**DANGER**

#### **Risk of injury if the personnel are not sufficiently qualified**

If unqualified personnel perform work on the freeze-dryer or are present in the danger zone of the freeze-dryer, hazards result that can cause serious injuries and considerable damage to property.

- Ensure that all the tasks are performed by personnel with the corresponding qualifications.
- Ensure that unqualified personnel stay clear of the danger zones.



**DANGER**

#### **Risk of fatal injury to unauthorised persons due to hazards in the danger zone or work area**

Unauthorised persons who do not fulfil the requirements described herein are not aware of the hazards in the work area. This is why there is a risk of serious or even fatal injuries for unauthorised persons.

- Ensure that unauthorised persons stay clear of the danger zone and work area.
- If in doubt, address these persons and instruct them to leave the danger zone and work area.
- Interrupt any running work if unauthorised persons are present in the danger zone or work area.

This manual uses the following personnel qualifications for various areas of activity:

#### **Qualified electrician**

Due to their special training, knowledge, experience and familiarity with the relevant standards and regulations, qualified electricians are in the position to perform work on electrical systems and to autonomously identify and prevent possible hazards.

Qualified electricians have been specifically trained for the environment in which they work and they are familiar with all the relevant standards and regulations.

Qualified electricians must fulfil the requirements as set out in the applicable legal provisions concerning the prevention of accidents.

**Specialised personnel**

Due to their special training, knowledge, experience and familiarity with the relevant regulations, specialised personnel are in the position to perform any tasks assigned to them and to autonomously identify and prevent possible hazards.

**Operating personnel**

It must be ensured that persons operating the unit

- have been specifically ordered to operate the unit and made aware of dangers originating from the freeze-dryer, supply media, starting and end products by the operator,
- are familiar with the fundamental regulations concerning workplace safety and accident prevention
- have been trained in terms of the operation of this unit, and
- have read and understood this operating manual (and in particular the safety sections and warning notes) and confirmed this with their signature.

**3.5 Informal safety instructions**

This operating manual is part of the product.

- The operating manual must be kept at the location of use of the RVC. Ensure that it is accessible at all times.
- The operating manual must be handed over to any subsequent owner or operator of the RVC.
- Any changes made must be added to the operating manual.
- In addition to the operating manual, the general and local rules and regulations concerning the prevention of accidents and the protection of the environment must also be supplied.
- Safety and danger indications on the RVC must be kept readable at all times. If necessary, they must be replaced.

### 3 Safety

## 3.6 Safety notes concerning the transport, set-up and connection and initial start-up of the freeze-dryer

The following notes and instructions must be observed in order to protect all persons and property.

### 3.6.1 General hazards



**WARNING**

#### General risk of injury

Among the general hazards during the transport, set-up, connection and commissioning of the unit are impact hazards, crushing hazards, grazing hazards, cutting hazards, etc.

This may lead to severe injuries.

- Comply with the fundamental health and safety rules and regulations as well as with the rules and regulations for the prevention of accidents!
- Wear personal protective equipment (safety shoes, work gloves and, if necessary, a hardhat)!

### 3.6.2 Hazards caused by improper transport



**DANGER**

#### Risk of injury caused by the uncontrolled movement of loads

Units that are not properly secured can, for example, slip or fall over.

- Prior to transporting the rotational vacuum concentrator, read the chapter (see chapter 4 - "Storage and transport")thoroughly!

### 3.6.3 Hazards caused by improper set-up



**WARNING**

#### Risk of injury due to poor accessibility of the unit

In cramped spaces or locations with poor accessibility, sharp edges and corners may protrude into the work area.

Injuries due to impact or abrasion may result.

- When setting up the rotational vacuum concentrator, ensure that it is freely accessible!
- Comply with the fundamental health and safety rules and regulations as well as with the rules and regulations for the prevention of accidents!

### 3.6.4 Hazards caused by an improper connection



**WARNING**

#### **Risk of injury due to improper connections**

Improper connections may lead to electrical malfunctions and failure when the unit is in operation.

This may lead to severe damage to health or even life-threatening injuries.

- The local supply voltage must match the voltage that is stated on the name plate of the unit.
- Do not position any hazardous materials, e.g. glass vessels containing liquids, within the 30 cm safety range around the unit. Spilled liquids can penetrate the unit and cause damage to the electrical and mechanical components.
- Do not store hazardous substances of any kind in the safety range around the rotational vacuum concentrator.
- Only qualified electricians are authorised to perform work on the electrical system of the unit!
- The electrical equipment of the unit must be checked at regular intervals.
- Defects such as loose connections or damaged cables must be eliminated immediately.

### 3.7 Safety notes concerning the operation

For the protection of persons and property, it is essential to observe the following instructions for operating the appliance.



**WARNING**

#### **Risk of injury due to improper operation!**

To ensure safe operation of the rotational vacuum concentrators, the following measures must be observed:

- Do not operate the rotational vacuum concentrator if it has not been installed properly!
- Never operate the rotational vacuum concentrator with accessories that are damaged.

### 3 Safety

#### 3.7.1 Electrical safety

CHRIST rotational vacuum concentrators are units of safety class I. The RVCs are equipped with a three-wire power cord and a 230 VAC safety plug with earthing contact. Please comply with the following points in order to preserve this safety feature:



**DANGER**

##### **Danger to life due to electric shock!**

There is a risk of electric shock if live components are touched.

Ventricular fibrillation, cardiac arrest or respiratory paralysis may occur..

- Ensure that the local mains voltage matches the nominal voltage that is stated on the name plate.
- Do not place any dangerous material, e.g. glass vessels containing liquid substances, within the safety area of 30 cm around the RVC. Spilled liquids may get into the RVC and damage the electrical or mechanical components.
- Work on the power supply system must only be performed by certified electricians.
- Inspect the electrical equipment of the unit regularly. Defects such as loose or burnt cables must be eliminated immediately.
- Never operate the rotary vacuum concentrator with the casing removed.

#### 3.7.2 Hazards through the lid



**WARNING**

##### **Danger of crushing when closing the lid!**

- Do not hold your fingers between the lid and the housing when closing the lid. Risk of crushing!

#### 3.7.3 Hazards due to damaged accessories



**WARNING**

##### **Risk of injury due to chemically or mechanically damaged accessories**

Even the smallest material fatigue, such as scratches or cracks, can lead to serious damage.

- Damaged rotors can cause a crash and, depending on the substance, harmful and hot substances may be released.
- Damaged accessories can cause glass breakage. This, in turn, may result in further damage to the unit and its accessories as well as to the loss of the samples.



### 3.7.4 Hazards due to hot surfaces



**WARNING**

#### **Risk of burns on hot surfaces!**

During operation of the rotational vacuum concentrator, the housing, lid and rotor chamber of the unit can reach surface temperatures of over +50°C .

- Open and close the lid only at the thermally insulated lid handle!
- Limbs must not come into contact with hot appliance or accessory parts. There is a risk of burns!
- Wear heat-resistant gloves when inserting or removing the rotor!
- Do not touch the surfaces intentionally!
- Never operate the rotary vacuum concentrator with the casing removed!
- Let the chamber cool down before maintenance work!

### 3.7.5 Hazards due to flammable and explosive substances



**DANGER**

#### **Hazards due to flammable and explosive substances!**

- Evaporating explosive or flammable substances is prohibited!
- Never operate the rotational vacuum concentrator in an explosive atmosphere!
- Do not evaporate substances that can create an explosive atmosphere!

### 3.7.6 Hazards caused by harmful products



**DANGER**

#### **Risk of poisoning/infection caused by the products**

When loading and unloading the chamber, the personnel are exposed to the product.

Skin contact or the inhalation of particles may cause severe damage to health depending on the product in question.

- Wear suitable protective clothes, gloves and respiratory protection!



**DANGER**

#### **Risk of poisoning/infection caused by the products**

During the maintenance of parts coming into contact with the product (e.g. all of the parts inside the chambers and the vacuum pump), the personnel may be exposed to product residues.

Skin contact or the inhalation of particles may cause severe damage to health depending on the product in question.

- Take suitable decontamination measures prior to commencing maintenance!
- Wear suitable protective clothes, gloves and respiratory protection, if necessary!

### 3 Safety

---

#### 3.7.7 Hazards caused by contaminated condensate (defrosting water)



**WARNING**

##### **Danger of poisoning/infection due to contact with the condensate (defrosting water)**

The condensate may contain harmful substances originating from the product.

Contact with the condensate may cause severe damage to health.

- Ensure the environmentally sound disposal of the condensate in compliance with the local rules and regulations!
- Wear suitable protective clothes, gloves and, if necessary, respiratory protection when performing maintenance tasks (especially when cleaning the valves and when replacing the seals)!

#### 3.7.8 Safety instructions for evaporation

The following instructions must be observed prior to every evaporation process:



**WARNING**

- Ensure that the RVC was set up and connected properly (see chapter 5 - "Set-up and connection").
- Maintain a safety distance of at least 30 cm (12 inches) around the RVC.
- Do not store any dangerous goods in the safety area of the RVC.
- Do not stay in the safety area longer than what is absolutely necessary for the operation of the RVC.
- Only use accessories that have been approved by the manufacturer (except for commercial vessels made of glass or synthetic materials). We explicitly warn against the use of equipment of poor quality. Breaking glass or bursting vessels can cause dangerous imbalances.
- Observe the instructions on the installation of accessories (see chapter 6.4.3 - "Installation of accessories").

### 3.7.9 Hazards due to the evaporation of harmful precursors

If infectious, toxic, pathogenic or radioactive substances are to be evaporated, the user is responsible for ensuring that all applicable safety regulations, guidelines, precautions and safety measures are observed.



**DANGER**

#### **Risk of poisoning/infection from the starting products!**

- Infectious, toxic, pathogenic and radioactive substances may only be evaporated in suitable vessels. For your own protection, it is essential to take appropriate precautions!
- Do not evaporate corrosive raw materials (especially acidic substances) without special protective measures and equipment (e.g. additional cold trap to protect the vacuum pump). It is essential to consult the manufacturer (see chapter 7.2 - "Service contact").



**DANGER**

#### **Explosion hazard due to azides!**

- Special care must be taken when handling azides, as a dangerous explosive is formed in combination with copper or non-ferrous metals! It is essential to consult the manufacturer (see chapter 7.2 - "Service contact").
- Local measures for the containment of harmful emissions must be observed (depending on the substances to be dried).
- Heat-resistant gloves are required as protective clothing for operating the rotary vacuum concentrator. The material to be dried may require further safety measures (e.g. drying of infectious, toxic, radioactive or pathogenic substances).

## 3 Safety

---

### 3.8 Safety devices



**WARNING**

The safety devices have been installed to protect the personnel using the unit against injury.

If all of the safety devices are not fully functional **and** if all of the operating elements are not freely accessible, serious health damage may result.

- The safety-relevant operating elements (mains power switch) must be accessible at all times!
- Do not manipulate, remove or disable the safety devices or guards in any way!
- The correct operation of the safety devices must be checked at regular intervals in accordance with the applicable national and international laws, rules and regulations concerning health and safety and the prevention of accidents!

#### 3.8.1 System check

An internal system check monitors the data transfer and sensor signals with regard to plausibility. Errors are detected by continuous self-monitoring of the system. Error messages are displayed in the process & equipment info menu (see (see chapter 6.5.3.4 - "Process and equipment information") or (see chapter 7.1.1 - "Error messages")).

#### 3.8.2 Power failure safety

The unit stores the current process parameters cyclically. In the event of a power failure, the electromagnetic stop valve will close automatically, the rotor chamber will be aerated by the aeration valve and the rotor decelerates brakeless. After the restart of the power supply, the evaporation process continues with the last stored parameters.

#### 3.8.3 Lid lock device

The RVC can only be started when the lid is properly closed. The lid can only be opened when the rotor has stopped. If the lid is open, the RVC cannot be started.

#### 3.8.4 Earth conductor check

For the earth conductor check, there is an equipotential bonding screw on the rear panel of the RVC. An earth conductor check can be carried out with the aid of a suitable measuring instrument.

### 3.9 Procedures in the event of hazards and accidents

**Hazardous electrical incident:**

- Switch the mains switch off in order to interrupt the power supply completely.

**Fire:**

- A fire in the electrical control system must be extinguished with a CO<sub>2</sub> fire extinguisher!
- Burning oil must be extinguished with a CO<sub>2</sub> fire extinguisher or powder fire extinguisher!

**Unconsciousness/paralysis due to nitrogen or refrigerant:**

- While ensuring your **own safety** (e.g. self-contained breathing apparatus) remove the affected persons to fresh air. Keep them warm and calm. **Get medical attention immediately!** In case of respiratory arrest, give artificial respiration.

**Electric shock:**

- While ensuring your **own safety**, interrupt the circuit as quickly as possible (mains switch at the right side of the freeze-dryer). Keep the affected persons warm and calm. **Get medical attention immediately!** Check consciousness and breathing continuously. In the case of unconsciousness or lack of normal breathing, perform cardiopulmonary resuscitation (CPR).

**Burns:**

- Cool small-area burns (e.g. finger) immediately with cold water for approximately 2 minutes.
- Do not cool if larger areas of the body surface are burnt since there is a risk of hypothermia.
- Cover the burns loosely and in a sterile manner (e.g. with sterile dressing).
- Keep the affected persons warm and calm.

### 3 Safety

---

#### Chemical burns:

- Eyes:  
Rinse the eyes thoroughly with plenty of water with the lid gap wide open for at least 15 minutes (eyewash bottle). **Consult an ophthalmologist immediately** even if there are no immediate symptoms. If possible, continue rinsing the eyes during the transport to the ophthalmologist.
- Respiratory tract:  
While using a **suitable breathing apparatus**, remove the affected persons to fresh air. Keep them warm and calm. **Get medical attention immediately!** In case of irregular breathing or respiratory arrest, give artificial respiration.
- Skin:  
Wash with plenty of water. Remove contaminated clothing. Rinse the affected skin areas under flowing water for at least 10 minutes. **Get medical attention immediately!**
- Oesophagus:  
Do not put anything into the mouth of an unconscious person. Wash the mouth out with water, If the person is conscious: Give the affected person plenty of water to drink (2 glasses maximum). Do not induce vomiting. In case of spontaneous vomiting, keep the head of the affected person lying on his/her stomach low in order to prevent any liquid from entering the respiratory tract. **Get medical attention immediately!**

**IF IN DOUBT; CALL AN EMERGENCY PHYSICIAN!**

### 3.10 Maintenance and cleaning of the rotational vacuum concentrator

The substances and materials that are used must be properly handled and disposed of (Please refer to the safety data sheets!). This particularly applies to

- the handling of lyes and acids.

Compliance with the national rules and regulations must be ensured.

### **3.11 Measures to ensure the safe operation of the rotational vacuum concentrator**

To ensure the safe operation of the rotational vacuum concentrator, the following measures must be taken prior to using the unit:

#### **Set-up, connection and operation**

- Ensure the proper set-up and correct connection of the rotational vacuum concentrator (see chapter 5 - "Set-up and connection").
- Perform a visual inspection of the rotational vacuum concentrator and its accessories prior to every use in order to detect damage.
- Do not bump or move the rotational vacuum concentrator during operation.
- Do not lean on or against the rotational vacuum concentrator during operation.
- Take the rotational vacuum concentrator immediately out of operation in the event of malfunctions. Eliminate the faults (see chapter 7 - "Malfunctions and error correction") or contact the service department of Martin Christ Gefriertrocknungsanlagen GmbH (see chapter 7.2 - "Service contact").
- Only specialised personnel are authorised to perform repairs.

#### **Fire protection**

- Some of the electrical circuits of the rotational vacuum concentrator are protected by way of fuses. When replacing the fuses, ensure to use fuses of the same type and rating.

#### **Safety range**

- Keep a safety range of at least 30 cm free around the rotational vacuum concentrator.
- Do not store hazardous substances of any kind in the safety range around the rotational vacuum concentrator.
- Do not position any potentially hazardous materials, e.g. glass vessels containing liquids, within the safety range. Spilled liquids can penetrate the unit and cause damage to the electrical and mechanical components.
- Persons must not remain in the safety area of the rotational vacuum concentrator for longer than is necessary for operation.

### 3 Safety

---

#### Accessories

- Do not use the rotational vacuum concentrator with damaged accessories.
- Observe the limit values concerning the load capacity of the accessories.
- Only use accessories that have been approved by Martin Christ Gefriertrocknungsanlagen GmbH. This does not apply to commercially available vessels made of glass or plastic. We explicitly warn against the use of equipment of poor quality! Breaking glass or bursting vessels can cause dangerous situations during the evaporation process.

#### Handling of hazardous substances

- The generally applicable regulations for handling flammable substances in laboratories/workplaces must be observed.
- The appropriate safety precautions must be observed during sample preparation as well as during the loading and unloading of the rotational vacuum concentrator.
- Be careful when handling hazardous substances such as strong acids or bases, radioactive substances and volatile organic compounds: If these types of substances leak or spill, they must be cleaned up immediately.
- If samples containing hazardous substances such as strong acids or bases, radioactive substances or volatile organic compounds leak or spill inside a chamber, they must be promptly cleaned up.
- Be careful when handling solvents: Sources of ignition must be kept away.
- When using flammable or hazardous solvents, the vacuum pump must be vented to or operated inside a fume hood.

### 3.12 Remaining hazards

All Christ rotational vacuum concentrators were built state-of-the-art and according to the accepted safety rules. However, danger to life and limb of the operator, or of third parties, or impairments of the units or other material assets cannot be completely excluded when the units are being used.

- Use the RVC only for the purpose that it was originally intended for (see chapter 1.2 - "Intended use").
- Use the RVC only if it is in a perfect running state.
- Immediately eliminate any problems that can affect safety.



## 4 Storage and transport

### 4.1 Storage conditions

In order to ensure the protection against mechanical and climatic influences, the guidelines of the German Federal Association for Wooden Packages, Pallets, and Export Packaging (Bundesverband Holzpackmittel, Paletten, Exportverpackung e.V.), the so-called HPE packaging guidelines, must be applied when packing and storing the RVC.

The storage must be:

- dust-free
- dry
- free from excessive temperature fluctuations
- free from mechanical load.

### 4.2 Dimensions and weight

Values for the RVC without a vacuum pump:

	RVC 2-33 IR
Height:	325 mm
Height with open lid:	715 mm
Width:	550 mm
Depth):	520 mm + 20 mm vacuum connection
Weight:	approx. 49 kg

### 4.3 Packaging

The RVC is packaged in a cardboard box or in a wooden crate, depending on the scope of supply.

- After opening the packaging, take out the box containing the accessories.
- Remove the packaging material.
- Lift the RVC upwards and out of the crate/cardboard box. When lifting the unit, always reach under it from the side.



**CAUTION**

The rotational vacuum concentrator **RVC 2-33 CDplus with infrared heating** weighs approx. 49 kg!

- Retain the packaging for any possible future transport of the RVC.

## 4 Storage and transport

### 4.4 Transport safety device

The following transport safety devices must be removed prior to start-up:

- The polystyrene element that covers the valve block at the back of the RVC must be removed.
- Remove the layers of paper between the lid and rotor chamber; they prevent the lid from getting stuck during the transport.

### 4.5 On-site transport

- When lifting the RVC, always reach under it from the side. Do not grab the unit at the plastic control panel (see the illustrations below).



**CAUTION**

The rotational vacuum concentrator **RVC 2-33 CDplus with infrared heating** weighs approx. 49 kg!

**correct**



**incorrect**



*Fig. 5: Lifting the RVC*

- When setting the unit down, ensure that the feet are upright (see the illustrations below).

**correct**



**incorrect**



*Fig. 6: Unit feet*

- Use suitable packaging for the transport, and if at all possible, the original packaging.

## 5 Set-up and connection

### 5.1 Installation site

Operate the RVC only in closed and dry rooms.

- The table must be stable and have a solid, even tabletop.
- Ensure sufficient ventilation. Do not place any paper, cloth, or similar material behind or under the unit, since otherwise the air circulation will be impaired.
- Keep a safety distance of at least 30 cm from the wall so that the vents in the unit remain fully effective.
- The ambient temperature must be in the range of +10°C to +25°C.
- Do not subject the RVC to thermal stress, e.g. by positioning it near heat generators.
- Avoid direct sunlight (UV radiation).

### 5.2 Power supply

#### 5.2.1 Type of connection



**DANGER**

#### **Danger to life due to electric shock!**

The operating voltage on the name plate must correspond to the local supply voltage!

Christ rotational vacuum concentrators are units of protection class I. Rotational vacuum concentrators of this type have a three-wire power cord with an IEC C13 connector.



**NOTE**

The removable power cord must not be replaced with a power cord of inadequate rating!

An equipotential bonding screw is located on the back (see chapter 10 - "Technical data"), This equipotential bonding screw can be used to perform an earth conductor check.

(see chapter 2.1.1 - "Functional and operating elements")

#### 5.2.2 Customer-provided fuses

Sufficiently rated fuse protection of the rotational vacuum concentrator in the electrical system of the building is required.

## 5 Set-up and connection

### 5.3 Aeration and air injection valve (valve block)

The rotational vacuum concentrator has an electromagnetic aeration and injection valve. After the completion of the evaporation process (manual mode or program-controlled mode), the rotor chamber will be aerated through this valve.

In addition, air can be injected. If the vacuum falls below the preselected vacuum value, this valve will open briefly to ensure a constant vacuum.



Fig. 7: Valve block



Unpressurised inert gas can also be used for aerating the rotor chamber.

#### Connecting combinations:

1. Connection for aeration and air injection with ambient air (state of delivery)

- 1 Aeration hose connection
- 2 Air filter
- 3 Fastener for non-required connection element; here: hose nozzle

2. Connection for aeration with ambient air and air injection with inert gas

- 1 Aeration hose connection
- 2 Air injection hose nozzle
- 3 Fastener for non-required connection element; here: air filter

## 5 Set-up and connection

3. Connection for aeration and air injection with inert gas
  - 1 Aeration hose connection
  - 2 Air injection hose nozzle
  - 3 Fastener for non-required connection element; here: air filter



### CAUTION

If gas (e.g. inert gas) is supplied through the hose nozzle for aeration or for "air injection", the threads of the hose nozzles must be sealed with thread sealant, e.g. Loctite® 542 (Loctite® part number: 54223, bottle with 10ml).

## 5.4 Vacuum connections

The vacuum connection is realised by way of a vacuum hose with standard flange connections, clamping rings, or chains, and centring rings.



### NOTE

The small flange connections must be installed correctly in order to prevent leaks (see chapter 7.1.5 - "Small flange connections").

- 1 Centring ring
- 2 Clamping ring
- 3 Flange connection

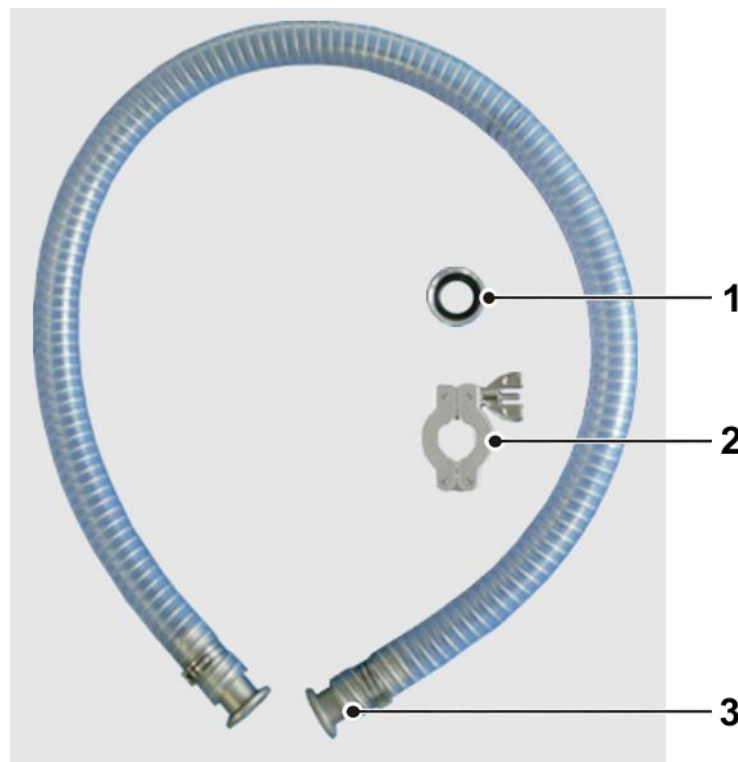

Fig. 8: Connecting pieces for vacuum connection

## 5 Set-up and connection

### 5.5 Option: Pressure control valve and vacuum sensor

If a pressure control valve and a vacuum sensor are used, they must be installed between the rotational vacuum concentrator and the vacuum pump, and they must be connected to the marked IEC C14 connector at the back of the unit (see chapter 2.1.1 - "Functional and operating elements").



Observe the installation direction of the pressure control valve!

- 1 Vacuum sensor
- 2 Pressure control valve

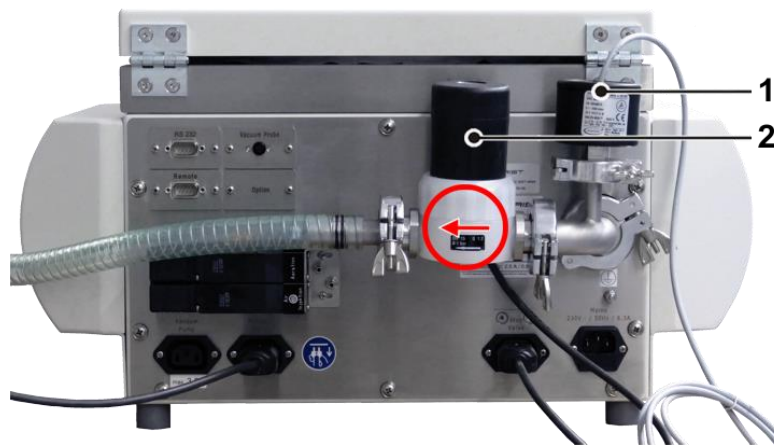

Fig. 9: Installation of the pressure control valve and the vacuum sensor

## 5.6 Connection of a vacuum pump and/or a cooling trap

In order to withdraw and condense the vapours that are formed, the RVC can be connected with further components.

### 5.6.1 Withdrawal of the vapours by a vacuum pump

The vapours are withdrawn by a vacuum pump, e.g. the vacuum diaphragm pump for chemical applications of Vacuubrand, followed by condensation in a liquid-cooled emission condenser. This application is suitable for low-boiling samples containing solvents.

The vacuum pump must be connected to the RVC. The connector of the stop valve must be plugged into the socket on the back of the unit (see chapter 2.1.1 - "Functional and operating elements").



The vacuum pump is supplied with power by the unit, but the maximum current for the vacuum pump is limited. It is absolutely essential to refer to the label of the electrical outlet for the vacuum pump (see the following picture)!

If the current requirement of the vacuum pump is higher than the value that is stated on the label, the pump must be supplied separately via an on-site power socket.

- 1 Label indicating the maximum current



Fig. 10: Indication of the maximum current for the vacuum pump (example)

The connector of the stop valve must be plugged into the socket "Stop valve" on the back of the unit.

- 1 RVC  
 2 Vacuum sensor  
 3 Stop valve  
 4 Vacuum hose  
 5 Vacuum pump

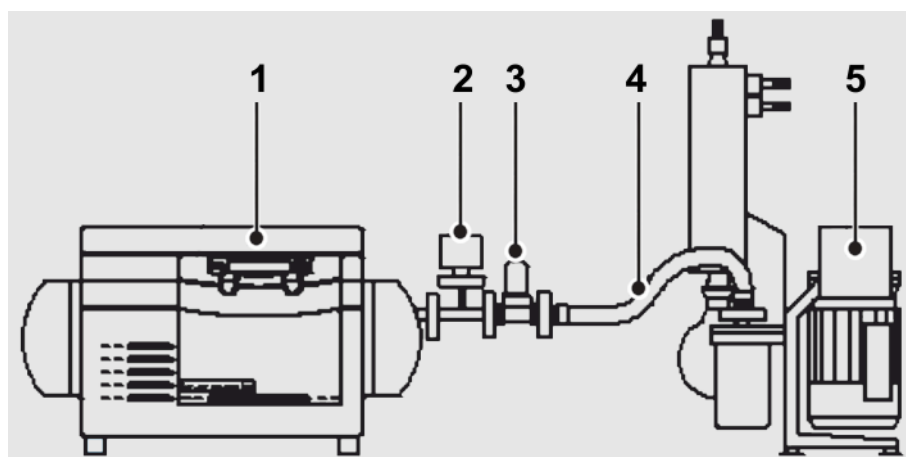

Fig. 11: Combination of the RVC with a vacuum pump and a stop valve

## 5 Set-up and connection

### 5.6.2 Condensation of the vapours upstream of the vacuum pump in a cooling trap

The vapours are condensed upstream of the vacuum pump in a cooling trap, e.g. "CT 02-50" or "CT 04-50".

The application is suitable for water-base, low-boiling samples containing solvents. The RVC, the cooling trap and the vacuum pump must be connected. The connector of the stop valve must be plugged into the socket on the back of the unit.

- 1 RVC
- 2 Vacuum pump
- 3 Cooling trap
- 4 Pressure control valve
- 5 Cover with connecting hoses
- 6 Stop valve
- 7 Vacuum sensor

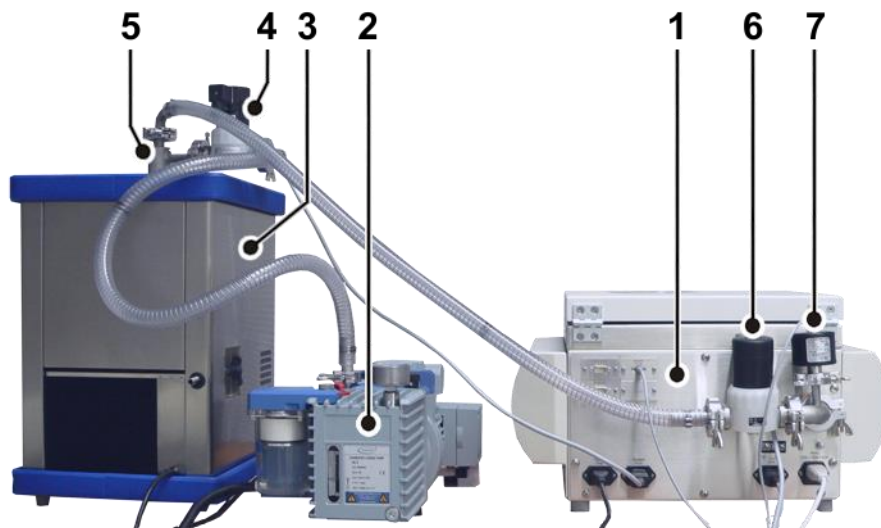
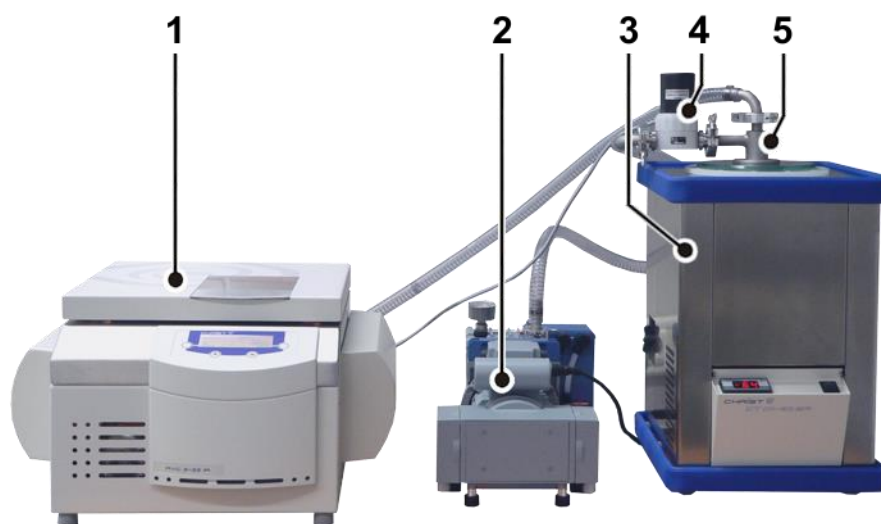

Fig. 12: Combination of the RVC with vacuum pump and cooling trap (front view)



**5.6.2.1 Option: Remote control of the FD cooling trap via RVC**

If Christ freeze dryers are used as a cooling trap, they can be remote-controlled by the rotational vacuum concentrator. In this case, the cooling trap will be automatically activated by the rotational vacuum concentrator during the warm-up and evaporation phase. In the standby mode, the cooling trap will be either switched off or continue operation, depending on the chosen option (chapter 6.5.3.5 - "Options" "Settings" / "Continuous operation coldtrap"). The ice condenser temperature is indicated in the values window of the rotational vacuum concentrator.

The cooling trap must be connected to the rotational vacuum concentrator with the aid of a zero cross cable (part no. 222 000). In addition, the option "Cooling trap control" must be activated (see chapter 6.5.3.5 - "Options").

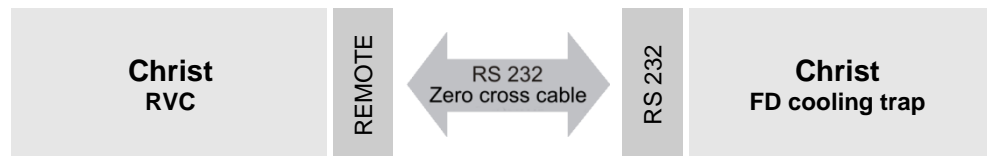

## 6 Operation

---

# 6 Operation

## 6.1 Initial start-up



**WARNING**

Before the initial start-up, please ensure that your RVC is properly set up and installed (see chapter 5 - "Set-up and connection")

## 6.2 Switching the RVC on

- Press the mains power switch on the right-hand side of the unit. The CDplus control unit performs a self-test and an initialisation. This may take several seconds.
- Follow the safety instructions and hazard warnings !

## 6.3 Opening and closing the lid

The lid can be opened if the rotor chamber is aerated and if the rotor is at a standstill. The rotational vacuum concentrator cannot be started if the lid is open.

- Select "mode" with the left-hand function key.
- Select "Open lid" with the up and down keys.
- To close, press slightly on the lid until both locks are locked.



**DANGER**

### **Danger of crushing when closing the lid!**

Do not place your fingers between the lid and the housing when closing the lid. Risk of crushing!

## 6.4 Installation of rotors and accessories

### 6.4.1 Installation of angle rotors

- Only use inserts that are suitable for the rotor (see chapter 11.2 - "Rotor program").
- Always load the opposite inserts of the rotors with the same accessories and fill to avoid imbalance.
- Push the loaded rotor onto the rotor shaft until it reaches the stop.

**i**  
NOTE

Depending on the version, up to three rotors can be pushed onto the rotor shaft at the same time.

- Follow the safety instructions and hazard warnings (see chapter 3 - "Safety")!

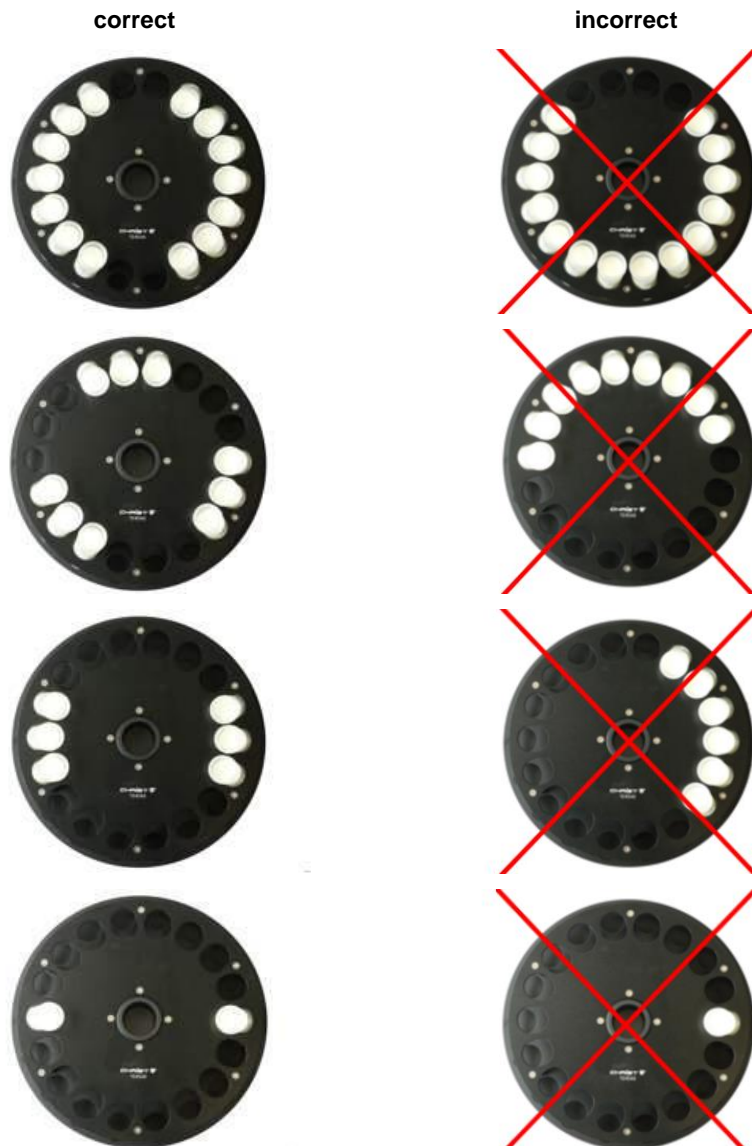

Fig. 13: Symmetrical loading of angle rotors

## 6 Operation

---

### 6.4.2 Installation of swing-out rotors

- Push the loaded rotor onto the rotor shaft until it reaches the stop.
- Follow the safety instructions and hazard warnings (see chapter 3 - "Safety")!

### 6.4.3 Installation of accessories

- Only use inserts that are suitable for the rotor (see chapter 11.2 - "Rotor program").
- In swing-out rotors, all places of a rotor must be loaded with buckets..
- Always load the opposite inserts of the rotors with the same accessories and fill to avoid imbalance.

#### Evaporation with different tube sizes

Working with different tube sizes is possible. In this case, however, it is very important that the inserts are installed symmetrically (see figure).

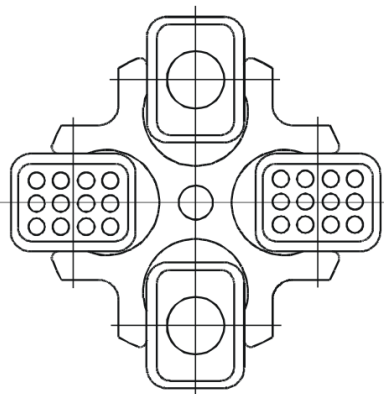

Fig. 14: Permissible loading of the swing-out rotor with different tube sizes

**Evaporation with low capacity**

The tubes must be installed symmetrically so that the buckets and their inserts are loaded evenly to avoid imbalance.

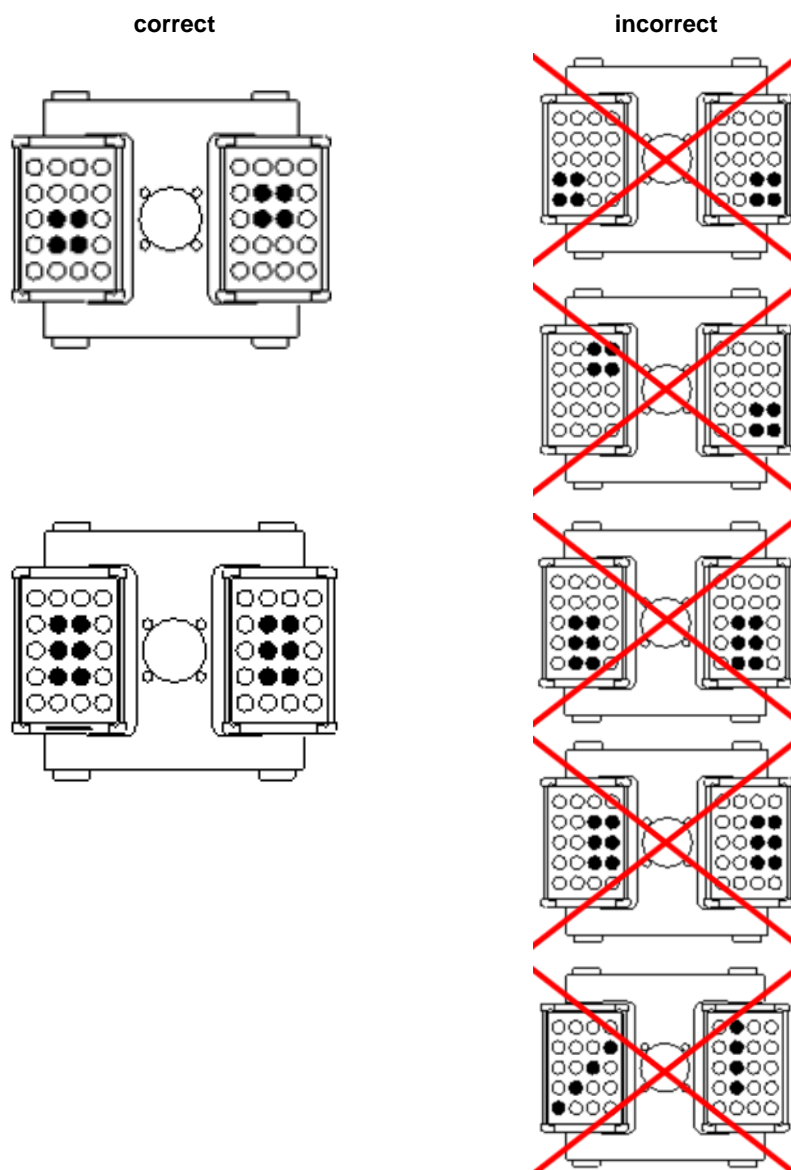

Fig. 15: Permissible loading of swing-out rotors with low capacity

**6.4.3.1 Tubes**

- Load the tubes outside of the rotational vacuum concentrator. Solvents in the buckets or rotor blocks cause corrosion.
- Fill the tubes carefully and arrange them according to their weight.
- Follow the safety instructions and hazard warnings (see chapter 3 - "Safety")!

## 6 Operation

### 6.4.3.2 Rotor blocks

- Always load the rotor blocks symmetrically with the same accessories and fill to avoid imbalance.

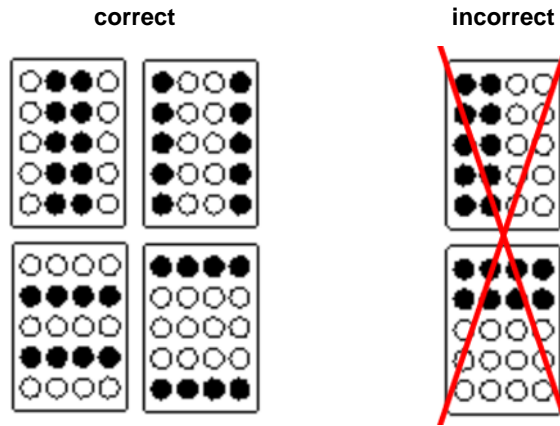

Fig. 16: Symmetrical loading of the rotor blocks

### 6.4.3.3 Buckets

- Load each bucket symmetrically to its pivotal point to ensure swinging to 90° under rotation.

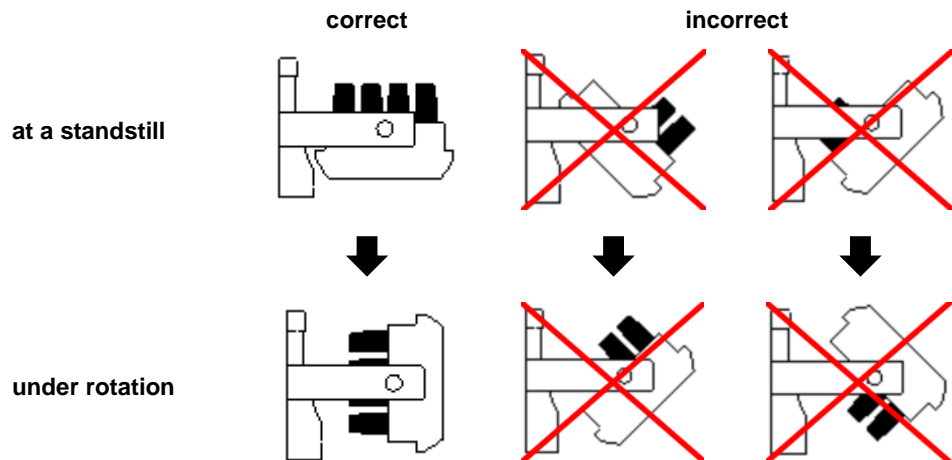
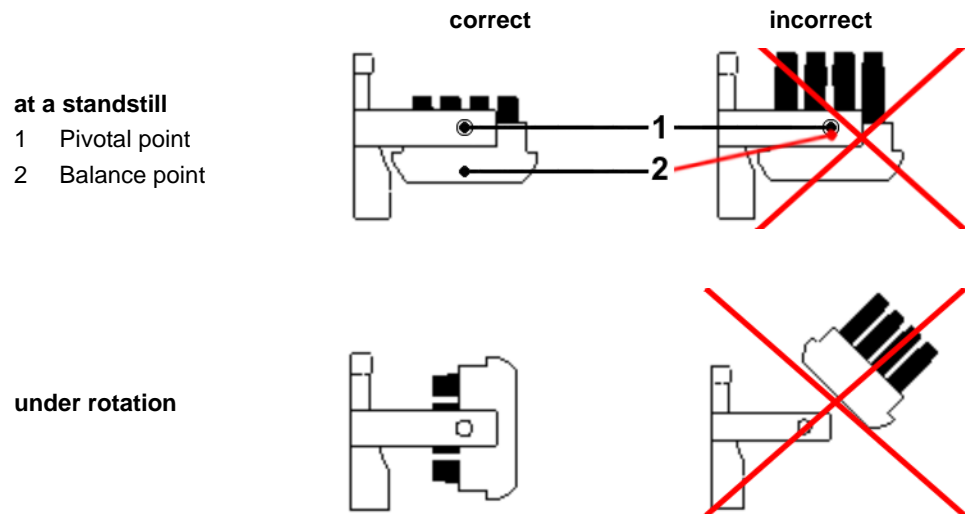

Fig. 17: Symmetrical loading of the buckets

**6 Operation**

- The balance point of the loaded bucket must be located considerably below the pivotal point. If the balance point is too near the pivotal point, the loaded bucket can be levered out of the bearings.



*Fig. 18: Loading of buckets considering the balance point*

## 6 Operation

### 6.5 CDplus control system

The control system CDplus ("Concentrator Display plus") stands for a convenient user interface for the intuitive control of evaporation processes under rotation.

#### 6.5.1 User interface

- 1 Left function key
- 2 Right function key
- 3 "Up" key
- 4 "Down" key
- 5 Display

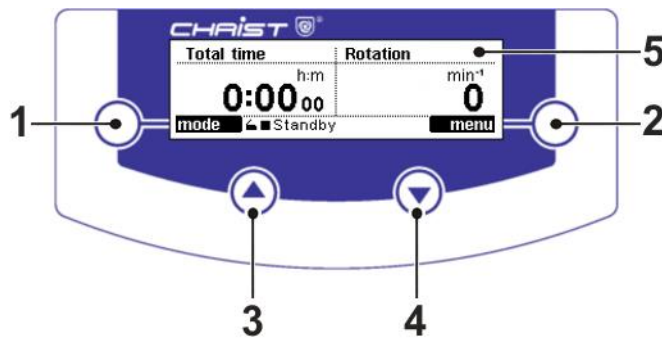

Fig. 19: User interface of the CDplus control system

#### Function keys (1+2)

The function of these keys depends on the menus and operating states of the installation. The current key function is displayed in the black field next to the key.



Fig. 20: Display of the assignment of the function keys; here: left key "mode", right key "menu"

#### Up and down keys (3+4)

These keys are used to select the available functions and values or to change the selected parameter values.

In addition, these keys also control the indication of the measurement value channels in the value windows. The "up" key is assigned to the left value window, whereas the "down" key controls the right value window.

- For a selection, press the "up" or "down" key repeatedly until the desired measurement value channel is indicated in the respective value window.



### Display (5)

The main window of the display is divided into three areas: the values windows, the assignment of the function keys and the status bar. The main window shows the process data, e.g. set values and actual values, menus and process-relevant information (see figure).

- 6 Values window
- 7 Assignment of the function keys
- 8 Status bar

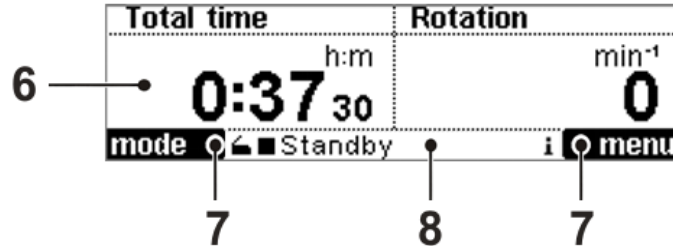

Fig. 21: Structure of the CDplus display

### Values window (6)

The value windows are displayed after the initialisation of the control system. There are two value windows with an identical layout. The indication of the measurement value channels is controlled by way of the "up" and "down" keys (see above).

- 9 Measuring channel
- 10 Set value (only shown in the run mode)
- 11 Unit of the measured value
- 12 Actual value

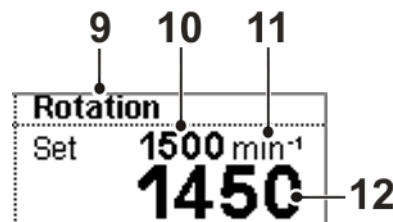

Fig. 22: Values window

The available measurement values can be displayed in the values window on the left as well as in the values window on the right so that a combination of the following values can be selected:

- Rotor speed
- Vacuum (only if a vacuum sensor is installed)
- Safety pressure (only if a vacuum sensor is installed)
- Rotor chamber temperature
- Ice condenser temperature (only if the option "Cooling trap control" is used)
- Total time (counts the time of the entire process run)
- Section time (counts the time of an individual phase, e.g. warm-up, program sections)

### Assignment of the function keys (7)

see "function keys" (1+2)

## 6 Operation

### Status bar (8)

The status bar shows information regarding the lid status, the operating mode, the active phase, and pending information. The status bar is visible at all times.

- 13 Lid status
- 14 Icon for the operating mode
- 15 Active phase
- 16 Info icon

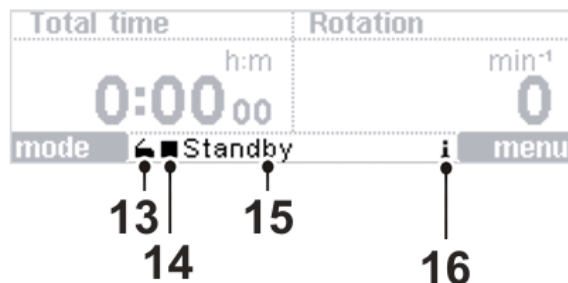

Fig. 23: Status bar

### Lid status (13)



The lid is open.

The lid is closed.

The lid is not completely closed.

- Press the right or left side of the lid down in order to close the lid completely.

### Operating mode (14)



**Standby** The rotational vacuum concentrator is in the standby mode. All aggregates are switched off.



The rotational vacuum concentrator is in the run mode. The timer is deactivated.



The rotational vacuum concentrator is in the run mode. The timer is activated.

### Active phases (15)

**Open lid** The rotor is at a standstill, the lid can be opened.

**Warm-up** The vacuum pump and/or the cooling trap are within the warm-up phase.

**Evaporation manual** The RVC is within a manual-controlled evaporation run.

**Evaporation program** The RVC is within a program-controlled evaporation run.

### Pending information (16)



If any messages are pending, the info icon flashes every second to draw the user's attention to error messages, process messages, or general information concerning the process or the unit.

The messages can be displayed in the process and equipment information window (see chapter 6.5.3.4 - "Process and equipment information")

### 6.5.2 Mode

The mode selection can be activated by pressing the left-hand function key "mode" in the active values window. The following phases are available:

- Press the left-hand function key "mode". The menu "start with phase..." appears (see figure).
- Select the desired menu item with the up and down keys.
- Press the right-hand function key "enter" to confirm.

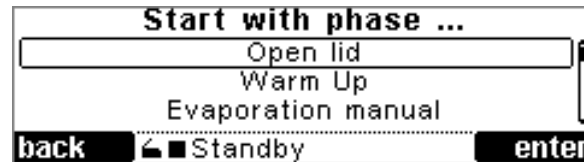

Fig. 24: Selecting the mode

#### Opening the lid

The lid can only be opened if the rotor is at a standstill. It is not possible to open the lid during an evaporation process.



**DANGER**

#### Hazards of burns on hot surfaces!

During the evaporation process, the housing, the lid and the interior of the rotational vacuum concentrator can reach surface temperatures of more than +50°C.

Risk of burns!

Before starting an evaporation process, the vacuum pump and the cooling trap should warm-up until they reach their respective operating temperatures.

For this purpose, the warm-up phase can be started. The rotor can optionally be installed. The warm-up time and the set value for heating can be selected (see chapter 6.5.3.5 - "Options").

During the warm-up:

- The rotor chamber is preheated - with or without rotor - when the lid is closed.
- The vacuum pump is switched on.
- The cooling trap is switched on if it is connected via the control system with the rotational vacuum concentrator (see chapter 5.6 - "Connection of a vacuum pump and/or a cooling trap"). If there is no connection, the cooling trap must be switched on separately.

When the preset warm-up time is over, the control unit displays the following message:

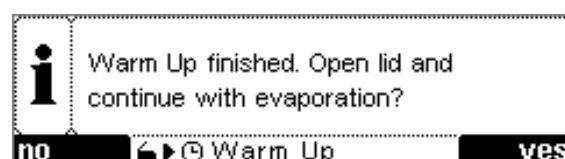

Fig. 25: Message after the warm-up

- Open the lid and remove the rotor in order to load it with the product or insert the loaded rotor.

## 6 Operation

- Close the lid. A menu appears:

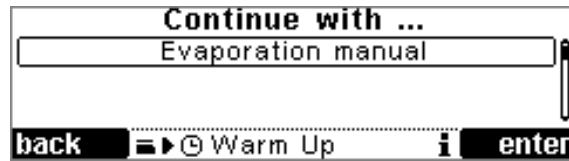

Fig. 26: Continuing the evaporation

- Continue the process by selecting "Evaporation manual" or "Evaporation program".

### Stopping the warm-up phase prematurely

During the warm-up phase, the functions "Open lid", "Continue with phase" or "Stop warm-up" can be selected with the right-hand function key "mode".

The warm-up is stopped by selecting one of the functions.

### **Manual or program-controlled evaporation**

If the unit is in the standby mode, the evaporation phase can be started directly. For this purpose, select from the menu "Start with phase" the item "Evaporation manual" or "Evaporation program".



The function "Evaporation program" can only be selected if a program was created before (see chapter 6.5.3.2 - "Program administration").

### Stopping the evaporation process prematurely

If the timer is active, the evaporation process will be stopped automatically when the preset time is over. The process can also be aborted manually.

- Open the menu "Select mode" with the left-hand function key.
- Select the function "Stop evaporation".
- Press the right-hand function key to confirm.

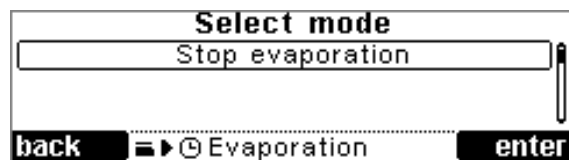

Fig. 27: Stopping an evaporation process

When the evaporation process is stopped, the chamber is completely aerated and the rotor stops. Then, the system inquires as to whether the lid should be opened.

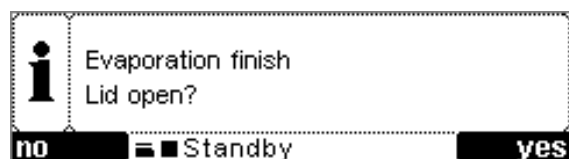

Fig. 28: Message after stopping an evaporation process

### 6.5.3 Main menu

The main menu can be activated by pressing the right-hand function key "menu" in the active values window. It contains the following items:

- Changing the set values for the manual mode (see chapter 6.5.3.1 - "Changing the set values for the manual mode ")
- Program administration (see chapter 6.5.3.2 - "Program administration")
- Special functions (see chapter 6.5.3.3 - "Special functions")
- Process- & equipment information system (see chapter 6.5.3.4 - "Process and equipment information")
- Options (see chapter 6.5.3.5 - "Options")

- 1 Menu list
- 2 Menu title
- 3 Focus
- 4 Scrollbar
- 5 Function key "Quit menu"
- 6 Function key "Open menu"

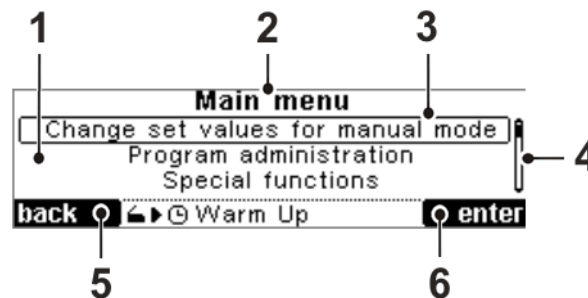

Fig. 29: Structure of the main menu

#### 6.5.3.1 Changing the set values for the manual mode

- Select the set value with the up and down keys. The selected value is displayed in a focus.



Fig. 30: Manual mode – selecting a set value

- Press the right-hand function key to start the editing mode. The focus is displayed in an inverted manner.



Fig. 31: The selected set value is displayed in an inverted manner

- Change the set value with the up/down keys.
- Press the right-hand function key "ok" to confirm.

The set value is edited. The Evaporation manual process is controlled by the following set values.

## 6 Operation

---

### Timer Evaporation

The time can be set between 1 minute and 200 hours. Using the down key as of the time 00:01 h:m the symbol ∞ appears. The timer is deactivated and the RVC operates continuously.

### Timer Heating

The value that is set under “Timer Evaporation” is also used for “Timer Heating”.

For some evaporation processes, however, it makes sense to reduce the heating time. In this case, the value “Timer Heating” can be changed. The value “Timer Heating” is always lower or equal to the value “Timer Evaporation”.

### Temperature

The control temperature can be set between  $-80^{\circ}\text{C}$  and  $+80^{\circ}\text{C}$ .



Because the RVC has no active cooling, it is not possible to reach temperatures below room temperature. Under certain conditions (e.g. if a frozen product is loaded) it may be reasonable to choose a temperature below room temperature.

### Vacuum (only if a vacuum sensor is installed)

This set value determines the vacuum in the rotor chamber. The value range is defined from 1,000 mbar to 0.1 mbar.

### Safety pressure (only if a vacuum sensor is installed)

When reaching the value of the → *safety pressure*, the heater for controlling the temperature of the bucket is started. The heat is supplied as long as the set value of the safety pressure is not exceeded. If the value of the safety pressure increases beyond the maximum limit, the heater will be switched off.

The set value of the safety pressure is defined at a value range from 1,000 mbar to 0.1 mbar.

- In the case of a set vacuum between 1 and 100 mbar, the set value of the safety pressure should be 5 mbar higher.
- In the case of a set vacuum between 100 and 1,000 mbar, the set value of the safety pressure should be 10 mbar above the set vacuum.

### Alarm temperature (only for RVC 2-33 CDplus with infrared heating)

The product temperature enables conclusions to be drawn concerning the end of the drying phase: When the medium has evaporated, the product sensor will no longer be cooled. As a result, the product temperature rises. Depending on the temperature sensitivity of the product, it may be useful to define a limit value, at which the heater will be switched off, via the alarm temperature. When selecting the limit value, it must be taken into consideration that the energy, which has already been supplied to the system (e.g. thermal energy from the rotor and rotor chamber), continues to heat the product even after the heater has been switched off.

The value range of the alarm temperature is between  $-20^{\circ}\text{C}$  and  $+60^{\circ}\text{C}$ .

**6.5.3.2 Program administration**

Contrary to a manual evaporation process, a program is used for a timer-controlled, pre-programmed process (evaporation program).

An evaporation program is divided into several sections. Every section of the program has set values for the time, temperature, vacuum, safety pressure, and speed.

You can create up to 16 individual evaporation programs. Up to 80 sections can be assigned to each of these programs. A program always consists of at least 3 sections.



The higher the speed is, the more thermal energy will be produced because of the waste heat of the drive unit and also because of the eddy current losses of the magnetic coupling. If thermosensitive products are processed, the speed can be set to a correspondingly low level in order to prevent a too high energy input and, thereby, the excessive heating of the product.



If the temperature increases too quickly during an evaporation process, the system is being supplied with too much energy. As a result, the vacuum may collapse, which in turn will interrupt the evaporation process and may destroy the product in the unit. In order to ensure a controlled process run, there is no sudden increase or decrease of the setpoint between the sections. Instead, the setpoint changes steadily. The defined section setpoint is reached at the end of the respective section.

Calculation of the gradient see chapter 11.1 - "Mathematical relations".

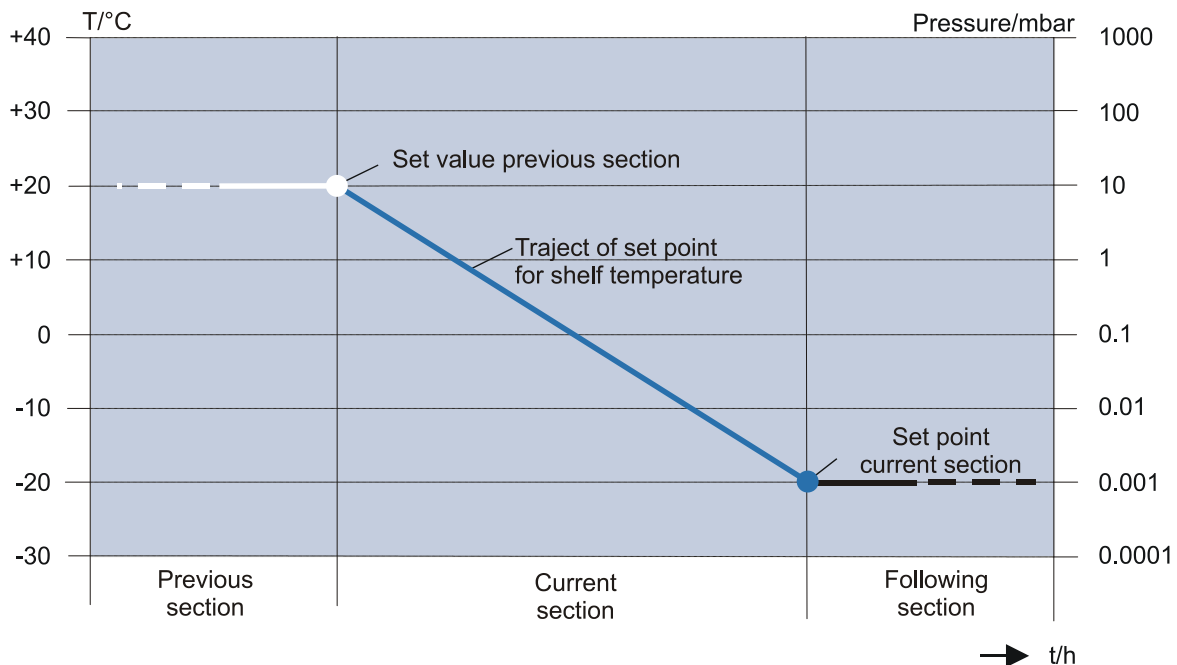

Fig. 32: Graphical representation of the course of the control setpoint

## 6 Operation

### Creating a new program

A new program can be created based on a fixed program template and adapted to specific needs by changing the set values and by adding and deleting certain sections. The control system automatically assigns a program number to every new program.

- Select "New program" from the menu "Program administration" (see figure) and confirm. The following message will appear:

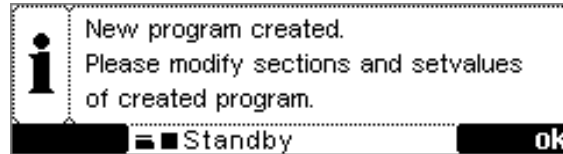

Fig. 33: Message "New program created"

- Press the right-hand function key to confirm.
- Continue as described under "Editing a program" (see below).

### Editing a program

- Select "Edit program" from the menu "Program administration" (see figure) and confirm. The program list is shown.

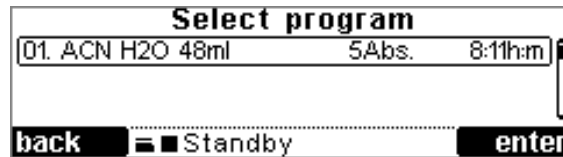

Fig. 34: Program list

- Select a program from the program list. It will be opened for editing.
- Open the menu "Program parameter" in order to change the program name. Use the function keys to position the focus in the program name. Use the up/down keys to change the character at the current focus position.
- At the last position of the program name, the right-hand key function changes to "ok" to enter the program name.

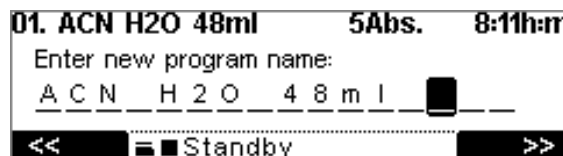

Fig. 35: Changing the program name



The sections of a program can be adapted under "Edit program sections". The set values and sections are displayed in a tabular form.

Section		Start	1	2
Zeit	h:m		0:10	1:00
Temperature	°C	30	30	60
Vacuum	mbar		24	24
<b>back</b>		Standby	<b>edit</b>	

Fig. 36: Program section table

- Use the up/down keys to scroll through the sections. The section to be edited is in the middle column of the table.
- Press the right-hand function key "edit" to confirm. The editing menu is displayed.

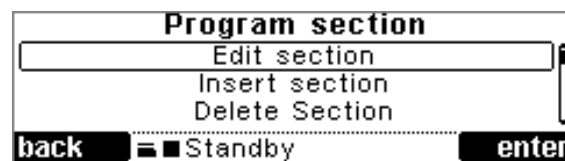

Fig. 37: Program section menu

- In this menu, the set values of the selected section can be changed, the selected section can be deleted, or a new section can be added to the selected section.
- Confirm the input and quit the menu.

### Copying a program

- Select "Copy program" from the program administration menu and confirm. The program list will be displayed.
- Select a program and confirm. A copy of the selected program will be created in a free program location.

### Deleting a program

- Select "Delete program" from the program administration menu and confirm.
- Select a program from the program list and confirm. A message will be displayed:



Abb. 38: Message for deleting a program

- Confirm the message and quit the menu.

## 6 Operation

### Program memory information

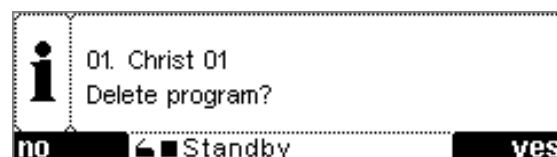
- Select "Program memory information" from the program administration menu and confirm. Information concerning free program locations and sections are displayed:

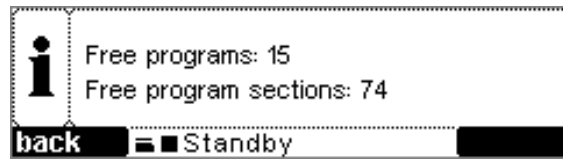

Fig. 39: Program memory information

### 6.5.3.3 Special functions

#### Pressure increase test



The → *pressure increase test* can only be performed if a vacuum sensor is installed.

#### Entering the set values

- Select "Special functions" from the main menu.
- Open the menu "Pressure increase test" and select "Parameter pressure increase test".
- Enter the set values, confirm and quit the menu.

#### Performing the pressure increase test

- Select "Special functions" from the main menu.
- Open the menu "Pressure increase test" and select "Start pressure increase test".

The pressure increase test will be performed. The test time progress and the measured pressure increase are displayed in a graphical form.

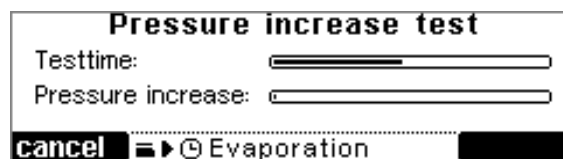

Fig. 40: Graphical presentation of the pressure increase test

When the test is finished, an information window pops up and shows the result of the pressure increase test.

### 6.5.3.4 Process and equipment information

The "Process & equipment Information " menu informs the user about any error, process, or system messages.

In the event of a message, a sound signal can be heard and the symbol "i" is displayed on the status bar. In addition, the process and equipment information is displayed. If the user is in a menu, the window will not be displayed until the user quits the main menu.

- 1 Message
- 2 Status of the Information
- 3 Number of messages pending
- 4 Function key for quitting the menu
- 5 Function key for acknowledging the message

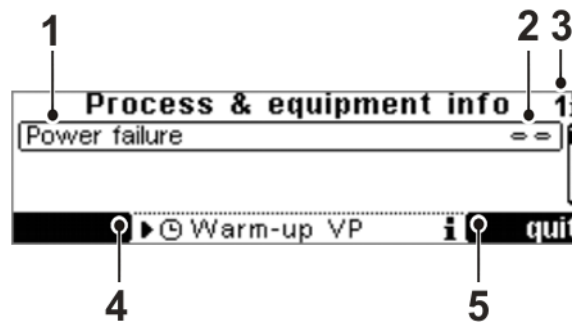

Fig. 41: Structure of the process & equipment info window

In addition, the menu can be opened at any time to check whether any messages are pending.



A detailed list of all messages can be found in chapter 7 "Malfunctions and error correction".

#### Information status

Every piece of information shown in the process & equipment information window receives a certain status:

 = Information present, not acknowledged

 ✓ Information present, acknowledged

 = Error no longer present, information not acknowledged

The sound signal continues until all the information is acknowledged.

Once some information is no longer present but has been acknowledged, the information will be removed from the process & equipment information window.

In order to quit the process & equipment information window, you have to acknowledge all of the pieces of information so that the left-hand function key "back" can be displayed.

## 6 Operation

### 6.5.3.5 Options



Fig. 42: Menu "Options"

#### Change display contrast

- Select the menu "Change display contrast".
- Change the contrast by pressing the up/down keys.
- Confirm the new setting by pressing the right-hand function key.

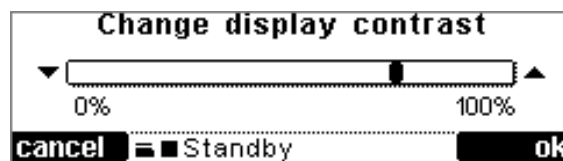

Fig. 43: Changing the contrast

#### Select language

The CDplus control system can be used in German or English.

- Select the menu "Select language".
- Select the language using the up/down keys.
- Confirm the input by pressing the right-hand function key.

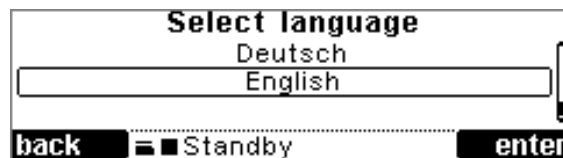

Fig. 44: Selecting a language

#### Settings

The Settings menu is used to customise the operation and process management of the control system.

- Select the value you want to set.
- Change the value using the up/down keys.
- Confirm the input by pressing the right-hand function key.

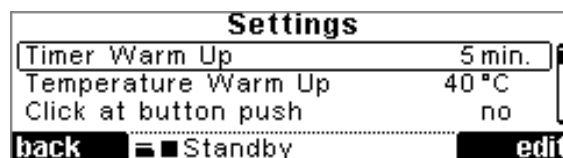

Fig. 45: Settings menu

### Timer Warm-up

You can set a warm-up time between 5 and 99 minutes.

### Temperature Warm-up

During the warm-up phase, the rotor temperature is set to the set temperature.

### Click at button push

If this function is activated, a brief sound signal can be heard whenever a key is pressed.

### High temperature resolution

Temperatures are displayed in the values window with a resolution of  $1/10^{\circ}\text{C}$ , normally with a resolution of  $1^{\circ}\text{C}$ .

### Rotor speed

The rotor speed can be set in a range between 100 rpm and 1,750 rpm.



We guarantee that a speed of 1,350 rpm can be reached with all of the available rotors. Higher speeds are possible in individual cases.

Continuous operation coldtrap (only if a cold trap is installed) and

Continuous operation VP

If these options are set to "yes", the vacuum pump and the cold trap will not be switched off after the evaporation. Instead, they will remain active. This is useful if several evaporation processes are started in succession.

### **Service menu**

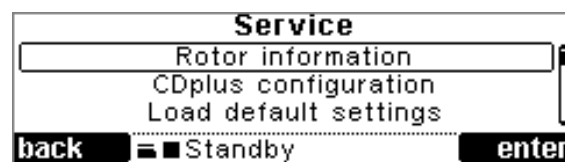

Fig. 46: Service menu

### Rotor information

This function is not supported by this type of unit.

## 6 Operation

---

### CDplus configuration

In this menu, accessories (options) have to be configured:

- VaCuum sensor
- Remote control cold trap
- Air injection
- Triple TMM (not available for all RVC types)
- Imbalance detection (not available for all RVC types)



### NOTE

- If an option is installed, it has to be activated with "yes".
- If the option is not installed, it has to be deactivated with "no".

### Load default settings

All set values and parameters are reset to the delivery status of the RVC.  
The reset requires confirmation.

### Extended service menu

The extended service menu is exclusively reserved for service engineers.  
This area is password-protected and not available to the user.

## 7 Malfunctions and error correction

### 7.1 General malfunctions

Malfunctions are displayed in the menu "Process & equipment info" (see chapter 6.5.3.4 - "Process and equipment information"). A sound signal sounds when an error message is generated.

- Eliminate the source of the problem (see the following chapters).
- Acknowledge the error messages by pressing the right-hand function key.

#### 7.1.1 Error messages

Error	Possible reason	Correction
<b>No vacuum sensor signal</b>	<ul style="list-style-type: none"> <li>• The control unit receives an invalid value from the vacuum sensor.</li> </ul>	<ul style="list-style-type: none"> <li>• Check the connecting cables and plug-in connections of the vacuum sensor. If necessary, replace the vacuum sensor.</li> </ul>
<b>No rotor chamber sensor signal</b>	<ul style="list-style-type: none"> <li>• The temperature sensor of the rotor chamber is disconnected or defective</li> </ul>	<ul style="list-style-type: none"> <li>• Contact the after-sales service (see chapter 7.2 - "Service contact")</li> </ul>
<b>No rotor sensor signal</b>	<ul style="list-style-type: none"> <li>• The rotor temperature sensor is disconnected or defective</li> </ul>	<ul style="list-style-type: none"> <li>• Contact the after-sales service (see chapter 7.2 - "Service contact")</li> </ul>
<b>No ice condenser sensor signal</b>	<ul style="list-style-type: none"> <li>• The data communication link to the cooling trap is interrupted, or the ice condenser temperature sensor is disconnected or defective</li> </ul>	<ul style="list-style-type: none"> <li>• Check the data link between the rotational vacuum concentrator and the cooling trap</li> </ul>
<b>Lid cannot be opened</b>	<ul style="list-style-type: none"> <li>• The rotor chamber is not aerated completely</li> </ul>	<ul style="list-style-type: none"> <li>• Aerate the rotor chamber completely</li> </ul>
<b>Lid contacts error</b>	<ul style="list-style-type: none"> <li>• The system has detected an open lid during evaporation. The rotor will be stopped immediately. The lid must be closed while the rotor is moving.</li> </ul>	<ul style="list-style-type: none"> <li>• Check the lid contacts. If necessary, contact the after-sales service (see chapter 7.2 - "Service contact")</li> </ul>
<b>Rotor overtemperature</b>	<ul style="list-style-type: none"> <li>• The maximum permissible rotor temperature of 85°C has been exceeded</li> </ul>	<ul style="list-style-type: none"> <li>• If the system does not cool down, disconnect it immediately from the power supply. Contact the after-sales service (see chapter 7.2 - "Service contact")</li> </ul>
<b>Chamber overtemperature</b>	<ul style="list-style-type: none"> <li>• The maximum permissible chamber temperature has been exceeded</li> </ul>	<ul style="list-style-type: none"> <li>• If the system does not cool down, disconnect it immediately from the power supply. Contact the after-sales service (see chapter 7.2 - "Service contact")</li> </ul>

## 7 Malfunctions and error correction

Error	Possible reason	Correction
<b>Permissible imbalance exceeded</b>	<ul style="list-style-type: none"> <li>The rotor will be stopped immediately, the process will also be stopped.                             <ul style="list-style-type: none"> <li>improper loading of the rotor</li> <li>glass breakage</li> <li>uneven evaporation</li> </ul> </li> </ul>	<ul style="list-style-type: none"> <li>Balance the load and restart the rotational vacuum concentrator. If the error occurs again, contact the after-sales service (see chapter 7.2 - "Service contact")</li> </ul>
<b>VSK3000 calibration error</b>	<ul style="list-style-type: none"> <li>Incorrect calibration of the vacuum sensor VSK3000</li> </ul>	<ul style="list-style-type: none"> <li>The sensor must be recalibrated (see separate operating manual)</li> </ul>

### 7.1.2 Process messages

Error	Possible reason	Correction
<b>Mains power failure</b>	<ul style="list-style-type: none"> <li>A mains power failure will be detected if the power supply is interrupted under normal conditions (run mode).</li> </ul>	<ul style="list-style-type: none"> <li>The process will continue once the mains power is available again. The process times will be reset to zero. The set control values will be preserved.</li> </ul>
<b>Factory settings loaded</b>	<ul style="list-style-type: none"> <li>All parameters are reset to the delivery status of the system.</li> </ul>	<ul style="list-style-type: none"> <li>The factory settings will be loaded if the corresponding menu command is executed in the service menu or if an error occurred in the parameter menu.</li> </ul>
<b>No rotor detected (only Triple TMM)</b>	<ul style="list-style-type: none"> <li>Check the rotor for correct installation.</li> </ul>	<ul style="list-style-type: none"> <li>If the error occurs again, contact the after-sales service (see chapter 7.2 - "Service contact").</li> </ul>
<b>Nominal rotor speed not reached</b>	<ul style="list-style-type: none"> <li>After two minutes, the rotor has still not reached 90% of its nominal speed.                             <ul style="list-style-type: none"> <li>set speed is too high</li> <li>drive moves sluggishly</li> </ul> </li> </ul>	<ul style="list-style-type: none"> <li>Check the set speed.</li> <li>When the rotor is at a standstill and the system is switched off, check whether the drive moves sluggishly, by hand. Contact the after-sales service (see chapter 7.2 - "Service contact").</li> </ul>
<b>Safety pressure not reached</b>	<ul style="list-style-type: none"> <li>The safety pressure inside the rotor chamber must be reached within 5 minutes after the start of an evaporation process.</li> </ul>	<ul style="list-style-type: none"> <li>Check whether the value that was entered for the safety pressure is not too low.</li> <li>Check the components for any possible leaks.</li> </ul>
<b>Ice condenser temperature not reached</b>	<ul style="list-style-type: none"> <li>Only if the "Cooling trap control" option is enabled: The ice condenser temperature must be <math>\leq -25^{\circ}\text{C}</math>.</li> </ul>	<ul style="list-style-type: none"> <li>If the temperature is not reached, the heater will be deactivated.</li> </ul>



## 7 Malfunctions and error correction

### 7.1.3 System messages

Error	Possible reason	Correction
Invalid system type		<ul style="list-style-type: none"> <li>Contact the after-sales service (see chapter 7.2 - "Service contact").</li> </ul>
IO communication error 0x21	<ul style="list-style-type: none"> <li>Failure of the CDplus IO module</li> </ul>	<ul style="list-style-type: none"> <li>Switch the system off and then on again. If the error occurs again, contact the after-sales service (see chapter 7.2 - "Service contact")</li> </ul>
IO communication error 0x30	<ul style="list-style-type: none"> <li>Failure of the reading unit of the electronic rotor system</li> </ul>	<ul style="list-style-type: none"> <li>Switch the system off and then on again. If the error occurs again, contact the after-sales service (see chapter 7.2 - "Service contact")</li> </ul>
IO communication error 0x40	<ul style="list-style-type: none"> <li>Failure of the motor control system</li> </ul>	<ul style="list-style-type: none"> <li>Switch the system off and then on again. If the error occurs again, contact the after-sales service (see chapter 7.2 - "Service contact")</li> </ul>
IO communication error 0x41	<ul style="list-style-type: none"> <li>Failure of the imbalance detection module</li> </ul>	<ul style="list-style-type: none"> <li>Switch the system off and then on again. If the error occurs again, contact the after-sales service (see chapter 7.2 - "Service contact")</li> </ul>

### 7.1.4 Emergency lid release system

If the rotational vacuum concentrator cannot be opened by way of the lid button, the lid can be unlocked manually.



**WARNING**

- Do not actuate the emergency release system until the rotor has stopped and the pressure has been equalised.
- Do not use the emergency release system during normal operation as an unlocked lid lock leads to a higher risk of injury!

- Switch the rotational vacuum concentrator off by way of the mains power switch and unplug the mains power plug.
- Check whether the rotor has come to a standstill and whether the rotor chamber has been completely aerated.

## 7 Malfunctions and error correction

---

- Pull the unit slightly over the edge of the desktop.

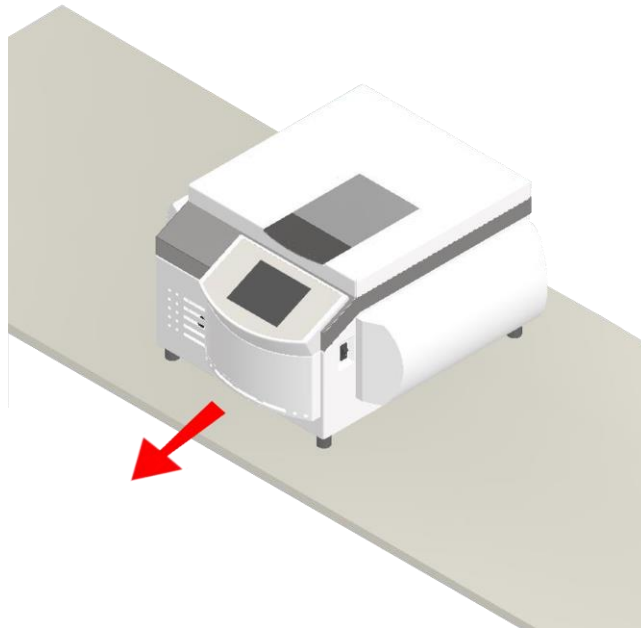

*Fig. 47: Pulling the unit slightly over the edge of the desktop*

- Tilt the unit upwards.

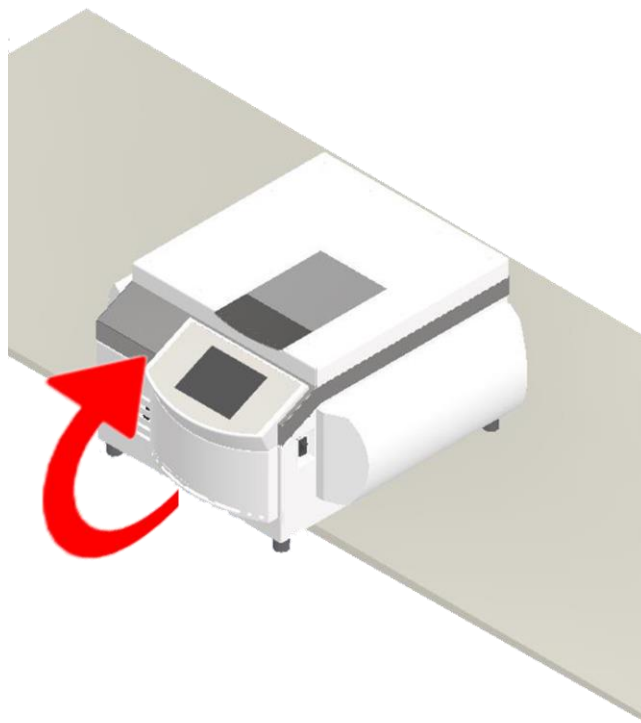

*Fig. 48: Tilting the unit upwards*

**7 Malfunctions and error correction**

- Prop the unit up.

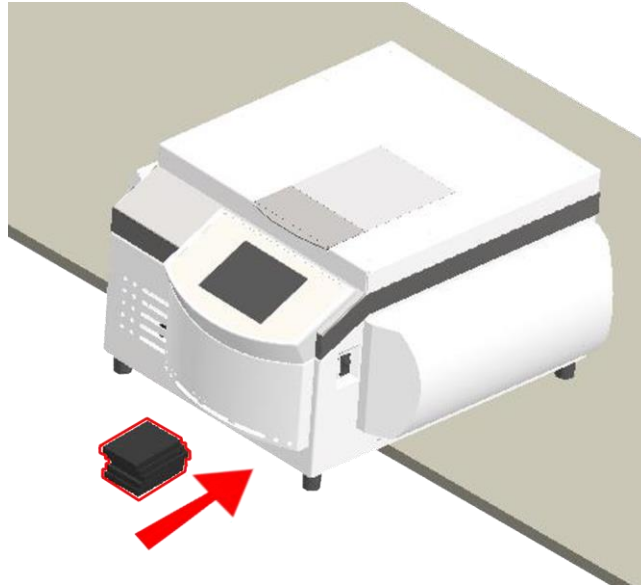

*Fig. 49: Propping the unit up*

- Ensure that the centre of gravity of the unit is still above the desktop. If necessary, the unit must be held or secured by a second person.

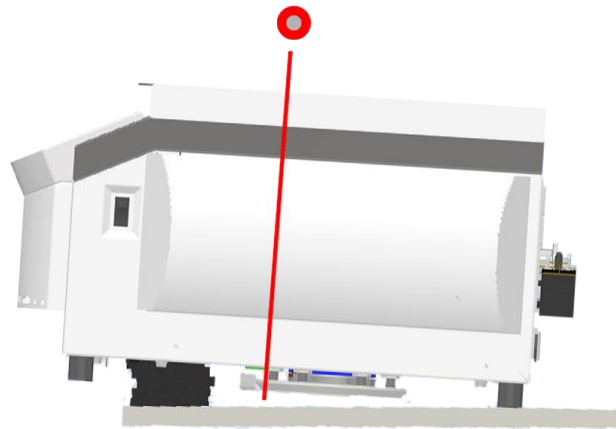

*Fig. 50: Centre of gravity of the unit (example)*

## 7 Malfunctions and error correction

The emergency release system is actuated by way of two plugs. They are located under the unit and connected to the lid lock via a release cord.

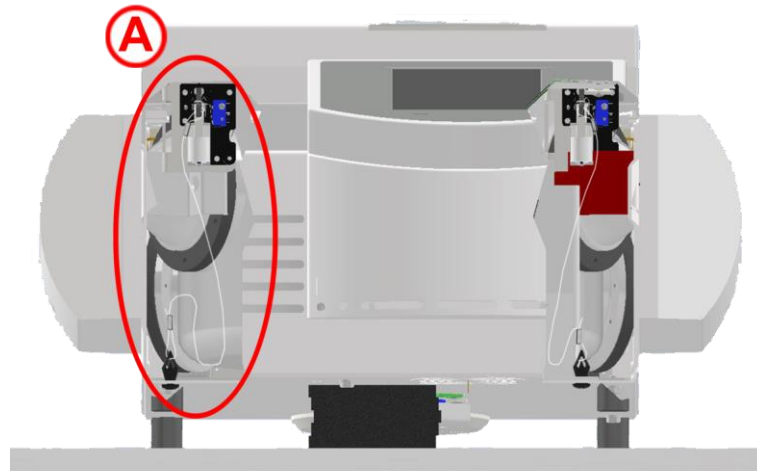

Fig. 51: Emergency release system

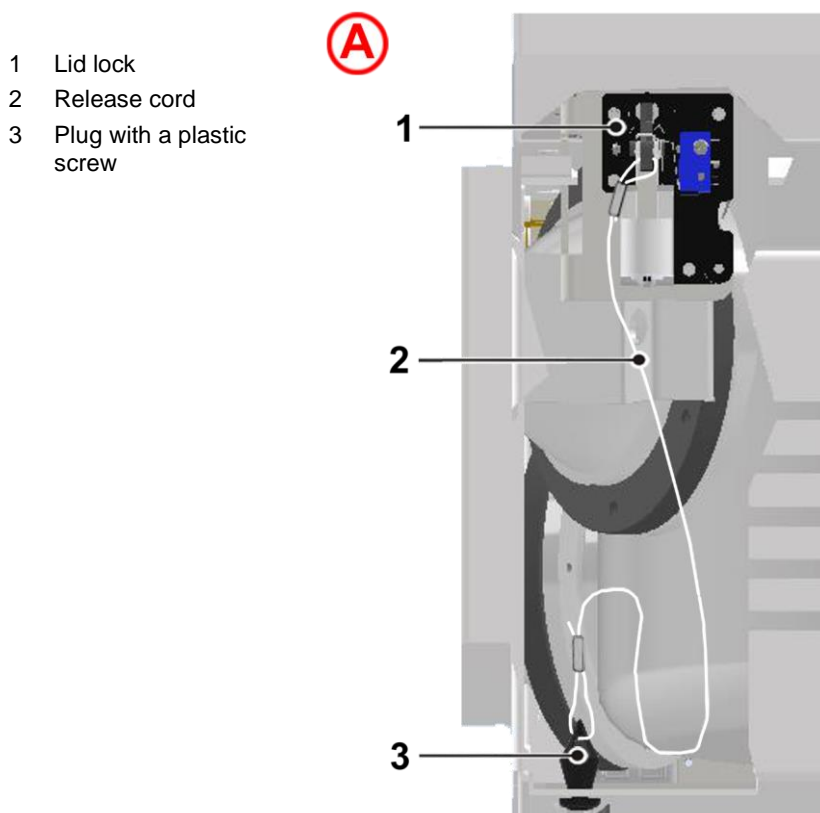
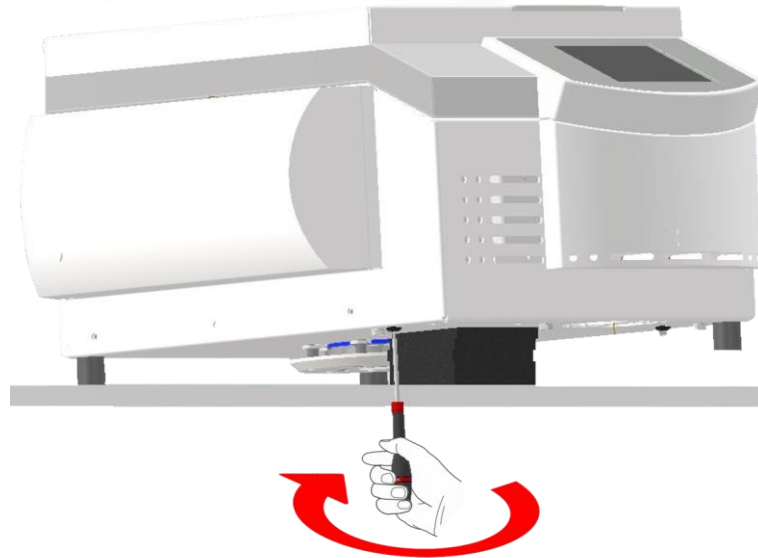

Fig. 52: Detail of the emergency release system

**7 Malfunctions and error correction**

- Unscrew the plastic screws on the right and left halfway (approx. 4 mm).



*Fig. 53: Loosening the plastic screw with a cross-point screwdriver (left)*

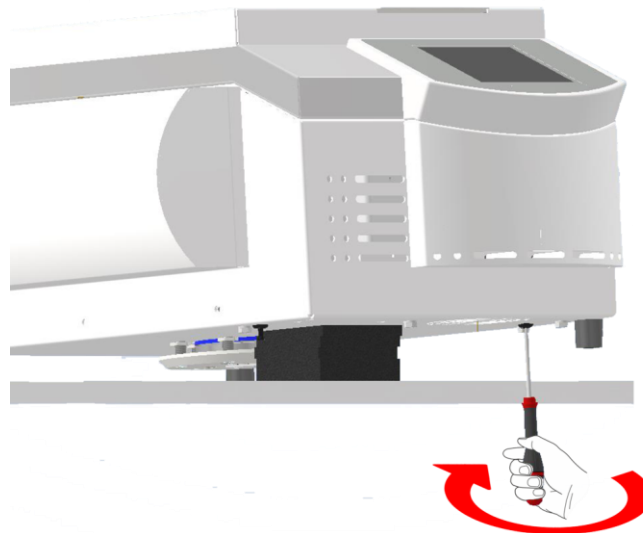

*Fig. 54: Loosening the plastic screw with a cross-point screwdriver (right)*

## 7 Malfunctions and error correction

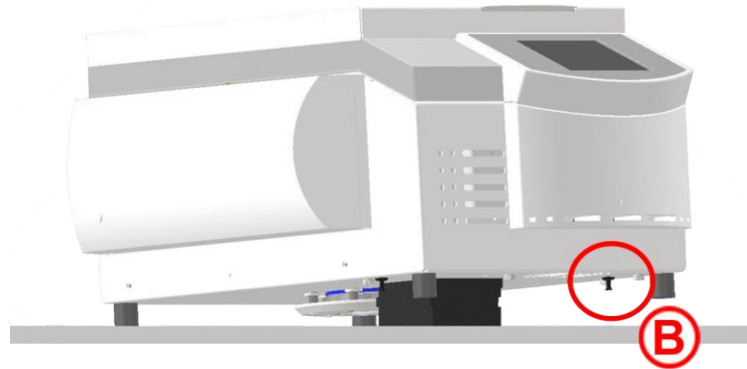

Fig. 55: Loosened plastic screws

- Grab the plastic screw and pull it out of the opening together with the plug.

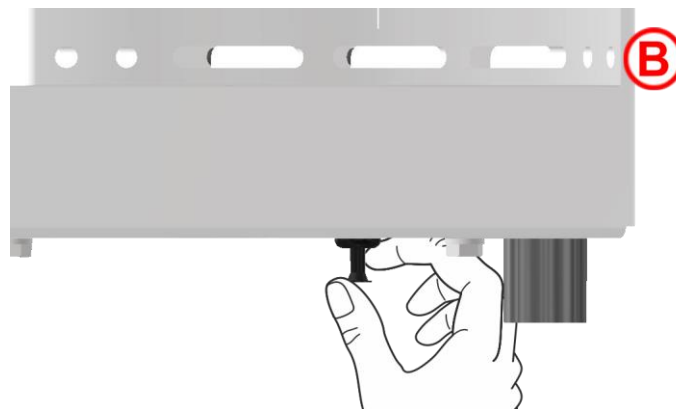
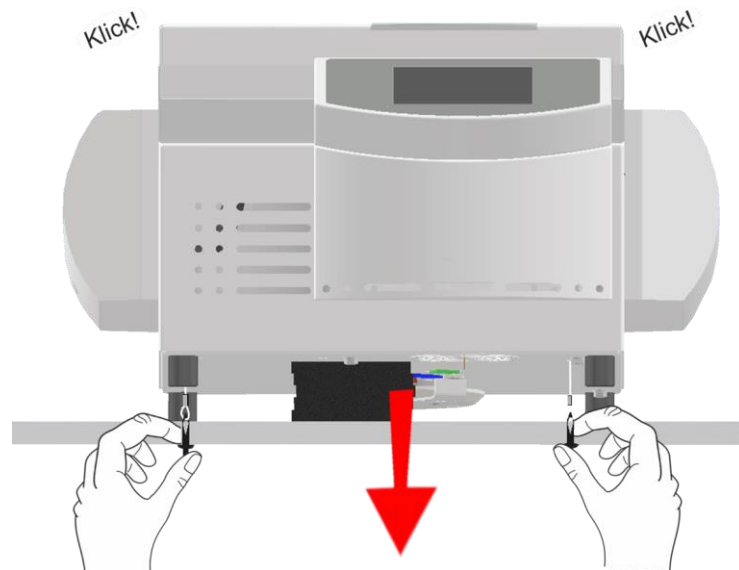

Fig. 56: Pulling out the plugs

- Pull the plug with the cord vertically downwards until you hear a clicking sound. Unlock the right and left lid lock in this manner.



The lid locks must be unlocked simultaneously!



*Fig. 57: Unlock the lid locks*

The lid opens.

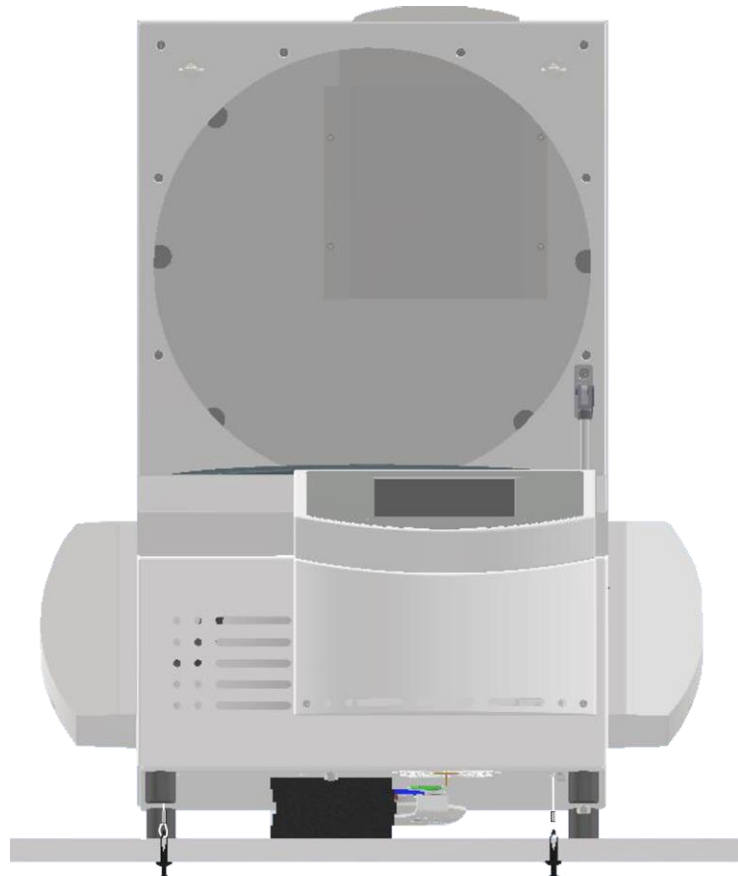

*Fig. 58: Opened RVC*

- After you have used the emergency lid release system, install the two plugs in reverse order.
- Eliminate the cause of the fault. If necessary, contact the service department.
- Set the unit up correctly.

## 7 Malfunctions and error correction

### 7.1.5 Small flange connections

Leakages are often due to improper small flange connections between the various components and hose connections or to leakages in the valves.

- Loosen the connection and place the centring ring (with sealing ring inside) in a centred manner between the flange connections.
- Seal the connection with the clamping ring or clamping chain by tightening the wing nut.
- Ensure that the centring ring neither slips out of place nor gets jammed.

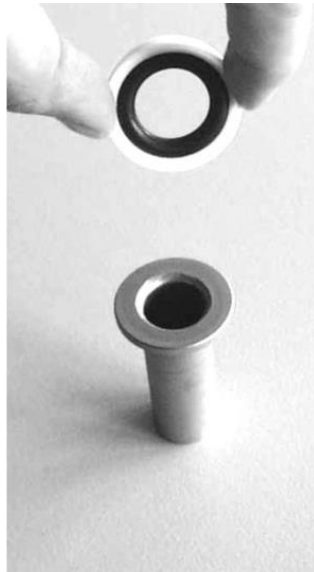

Fig. 59: Small flange and centring ring



Fig. 60: Small flange with centring ring and small flange



Fig. 61: Attaching the clamping ring



Fig. 62: Tightened clamping ring



## 7.2 Service contact

In the event of queries, malfunctions, or spare part enquiries:

### **From Germany:**

Contact

Martin Christ Gefriertrocknungsanlagen GmbH

An der Unteren Söse 50

37520 Osterode (Germany)

Tel. +49 (0) 55 22 / 50 07-44 44

E-mail: support.lab@martinchrist.de

### **Outside Germany:**

Contact our agency in your country. All agencies are listed at  
[www.martinchrist.de](http://www.martinchrist.de) → [Sales Partners]



If you would like to utilise our after-sales-service, please state the type of your RVC and its serial number.

## 8 Maintenance and service

---

### 8 Maintenance and service

The rotational vacuum concentrator and the accessories are subject to high mechanical stress. Thorough maintenance performed by the user extends the service life and prevents premature failure.



#### CAUTION

If corrosion or other damage occurs due to improper care, the manufacturer cannot be held liable or subject to any warranty claims.

- Use soap water or other water-soluble, mild cleaning agents for cleaning the RVC and the accessories.
- Do not use any corrosive or aggressive substances.
- Do not use solvents.
- Do not use agents with abrasive particles.
- Do not expose the RVC or its accessories to intensive UV radiation (e.g. sunlight) or thermal stress (e.g. by heat generators).

#### 8.1 Maintenance

##### 8.1.1 General

The general state of the freeze-dryer must be checked at regular intervals. Any defects must be eliminated immediately! The following points are of particular importance:

- dirt
- leaks
- corrosion
- bent system components
- loose screw and flange connections
- higher noise levels
- loose cables
- missing or illegible safety notes and hazard warnings
- missing or illegible inscriptions on components, pipes (direction of flow) and cables
- etc.

**Cleaning of the rotational vacuum concentrator****WARNING****Risk of burns on hot surfaces**

After a drying process, some or all of the surfaces inside the chamber may still be hot.

There is a risk of burns when touching the surfaces.

- Wear suitable protective clothes and gloves!
- Do not touch the surfaces on purpose!
- Let the chamber cool down prior to commencing the maintenance!

**DANGER****Risk of poisoning/infection caused by the products**

When performing maintenance work on parts coming into contact with the product (e.g. all parts inside the chamber), the personnel may be exposed to product residues.

Skin contact or the inhalation of particles may cause severe damage to health depending on the product in question.

- Take suitable decontamination measures prior to commencing the maintenance!
- Wear suitable protective clothes and gloves!

- Switch the rotational vacuum concentrator off by actuating the mains power switch and disconnect the power cord from the wall outlet before cleaning.
- If the freeze-dryer has been contaminated with toxic, radioactive, or pathogenic substances, clean the inside immediately with a suitable decontamination agent (depending on the type of contamination, see (see chapter 8.2 - "Disinfection of the rotor chamber and accessories")).
- Remove product residues thoroughly with a cloth.
- Open the lid/ rotor chamber when the rotational vacuum concentrator is not in use so moisture can evaporate.

## 8 Maintenance and service

### 8.1.2 Rotor chamber

In case of soiling or glass breakage, the rotor chamber, rotor holder and rotor must be cleaned immediately to avoid corrosion.

- 1 Countersunk Torx screws
- 2 Rotor-side magnetic coupling
- 3 Cap
- 4 Electronic temperature measuring system of the rotor axle
- 5 Rotor holder
- 6 Rotor chamber

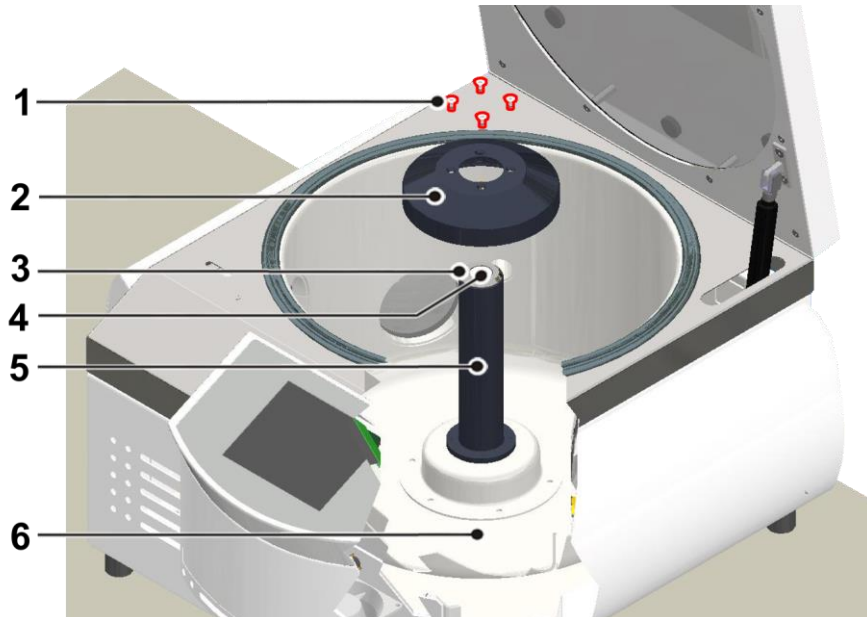

Fig. 63: Rotor chamber and rotor holder with a magnetic coupling

#### Removing the rotor holder and rotor-side magnetic coupling

Open the lid of the unit.

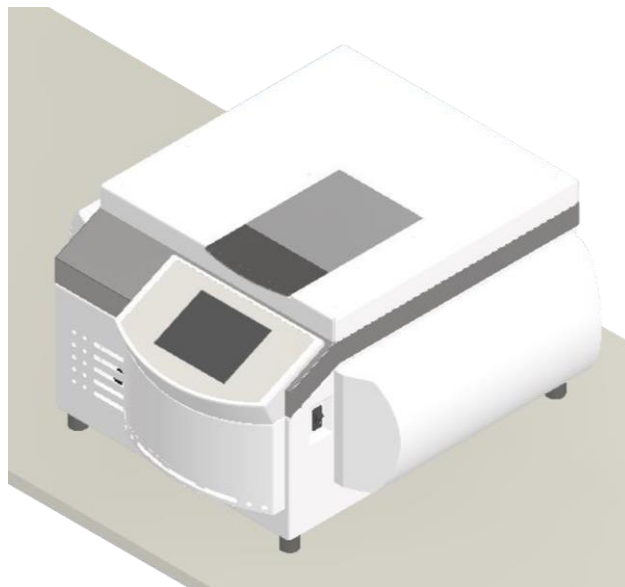

Fig. 64. Unit with a closed lid

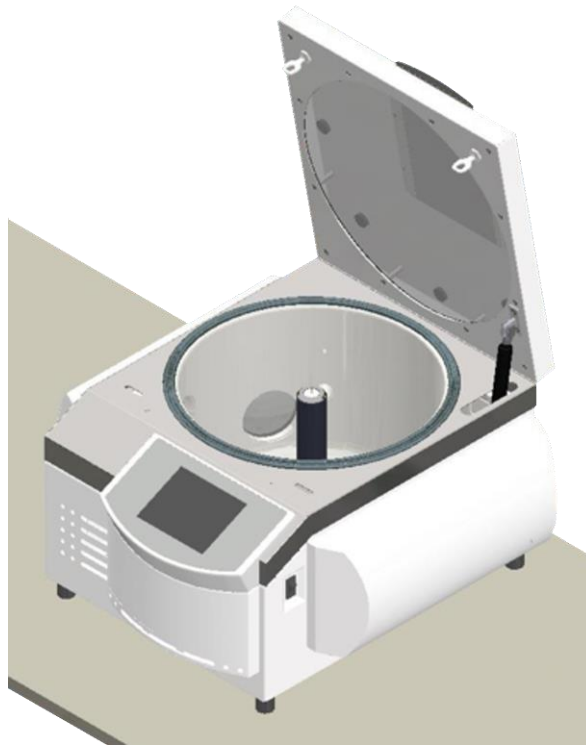

Fig. 65: Unit with an open lid

- Set the mains power switch to OFF and disconnect the mains power cable.



**DANGER**

**Danger of burns on hot surfaces!**

Let the rotor chamber cool down to room temperature!

- Use the TX15 Torx L-key to loosen the screws.

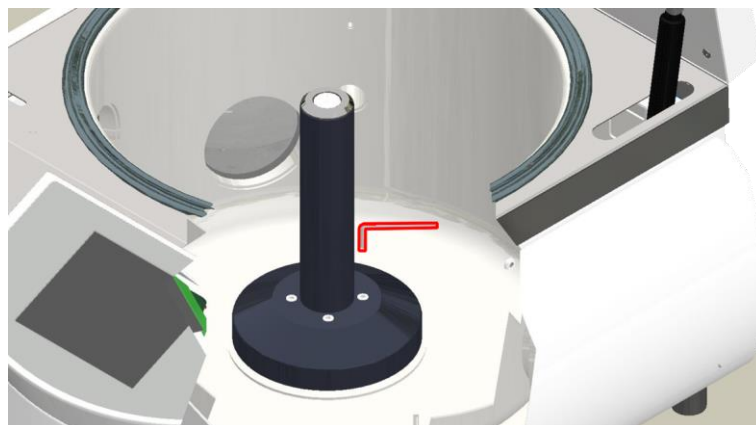

Fig. 66: Using an L-key

## 8 Maintenance and service

- Loosen all four fastening screws.

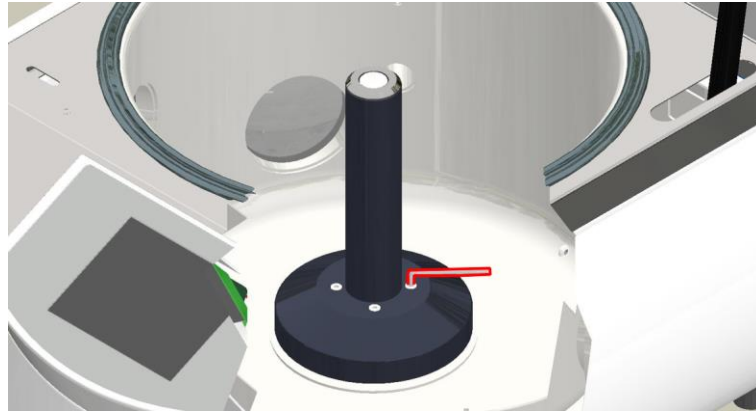

Fig. 67: Loosening the fastening screws

- Remove the magnetic coupling by lifting it up and off the rotor holder.

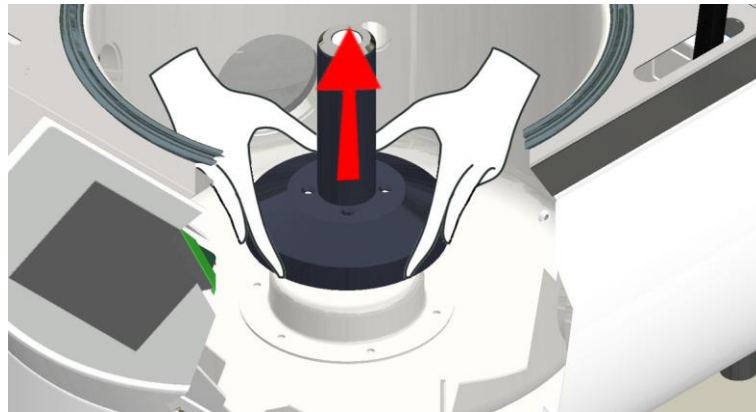

Fig. 68: Removing the magnetic coupling

- Then, the rotor chamber, rotor holder and magnetic coupling can be cleaned.



### CAUTION

Ensure that cleaning agents or disinfectants cannot flow into the opening at the bottom of the rotor chamber (see the following illustration)! This may lead to irreversible damage in the motor chamber.

- Wipe the rotor chamber, rotor holder and magnetic coupling clean or clean them with water and soap or a disinfectant.

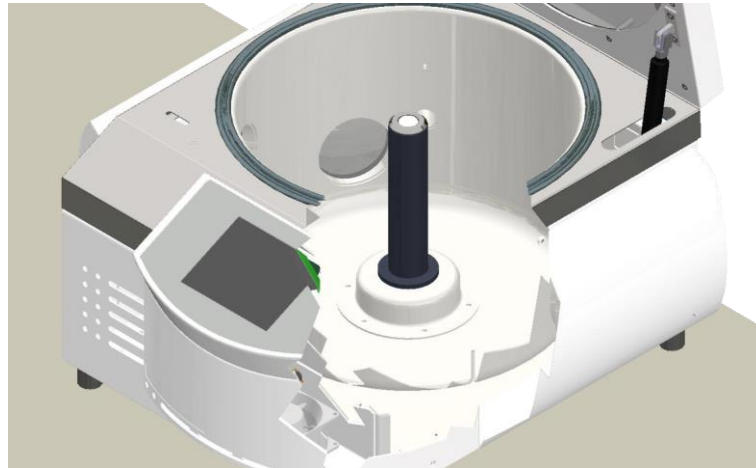

Fig. 69: Chamber and rotor holder to be cleaned

### Installing the rotor holder and rotor-side magnetic coupling



**WARNING**

#### Risk of crushing when installing the magnetic coupling

The magnets of the magnetic coupling and the ones of the motor attract one another (red, see the illustration) so that there is a risk of crushing your fingers between the components!

- When installing the magnetic coupling, do not put your fingers under the magnetic coupling!

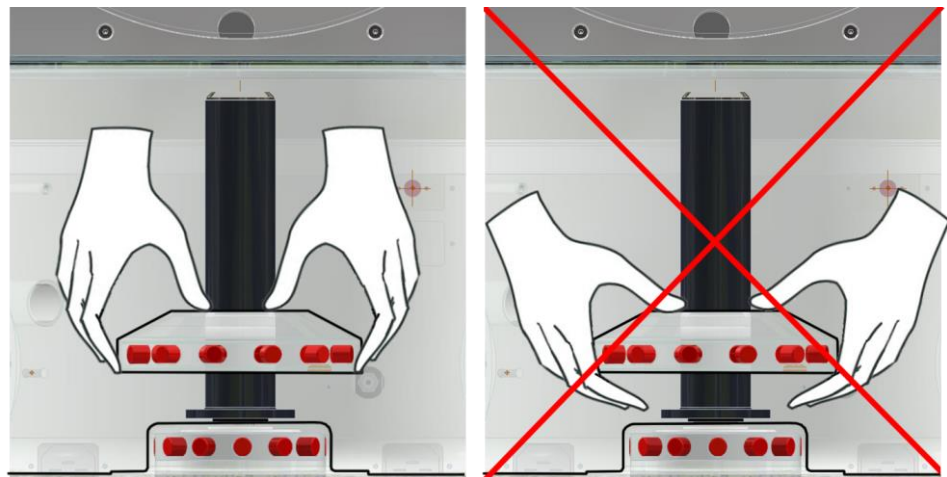

Fig. 70: Installing the magnetic coupling

- Grab the magnetic coupling by its sides and install it in the rotor chamber.
- Install the parts and assemblies in reverse order with regard to their removal.
- Connect the mains power connector and switch the unit on via the mains power switch.
- Perform a test run.

## 8 Maintenance and service

---

### 8.1.3 Accessories



#### CAUTION

For the care of the accessories, special safety measures must be considered as these are measures that will ensure operational safety at the same time.

Chemical reactions as well as stress-corrosion (combination of oscillating pressure and chemical reaction) can affect or destroy the metals. Barely detectable cracks on the surface can expand and weaken the material without any visible signs.

- Check the material regularly (at least once a month) for
  - cracks
  - visible damage of the surface
  - pressure marks
  - signs of corrosion
  - other changes.
- Replace any damaged components immediately for your own safety.
- Immediately rinse off the rotors or accessories if any liquids that may cause corrosion come into contact with them.
- Clean the accessories outside the rotational vacuum concentrator once a week or preferably after each use.
- If the rotors or accessories have been contaminated with toxic, radioactive, or pathogenic substances, clean them immediately with a suitable decontamination agent (depending on the type of contamination). Take suitable precautions for your own safety if there is a risk of toxic, radioactive, or pathogenic contamination.

#### 8.1.3.1 Aluminium accessories

Especially aluminium parts are susceptible to corrosion.

- Acid-containing cleaning agents and alkaline cleaning agents must be avoided.
- Grease aluminium parts at least once a week with slushing oil for the protection against corrosion.

This essentially increases their service life and reduces susceptibility to corrosion.



#### 8.1.4 Glass breakage

**CAUTION**

In the case of glass breakage, immediately remove all glass particles (e.g. with a vacuum cleaner). Replace the rubber cushions since even thorough cleaning will not remove all glass particles.

Glass particles will damage the surface coating (e.g. anodising) of the buckets, which will then lead to corrosion.

Glass particles in the rubber cushions of the buckets will cause glass breakage again.

Glass particles on the pivot bearing of the load-bearing bolts prevent the buckets and rotor blocks from swinging evenly, which will cause an imbalance.

Glass particles in the rotor chamber will cause metal abrasion due to the circulation. This metal dust will not only pollute the rotor chamber, rotor, and materials to be evaporated but also damage the surfaces of the accessories, rotors, and rotor chamber.

##### **In order to completely remove the glass particles and metal dust from the rotor chamber**

- Grease the upper third of the rotor chamber with e.g. Vaseline.
- Then, let the rotor rotate for a few minutes at maximum speed and atmospheric pressure. The glass and metal particles will now collect at the greased part.
- Remove the grease with the glass and metal particles with a cloth.
- If necessary, repeat this procedure.
- Clean the rotor shaft.

## 8.2 Disinfection of the rotor chamber and accessories

**DANGER**

If dangerous materials (e.g. infectious and pathogenic substances) are used, the RVC and the accessories must be disinfected.

- Use commercially-available disinfectants such as, for example, Incidur<sup>®</sup>, Meliseptol<sup>®</sup>, Sagrotan<sup>®</sup>, Buraton<sup>®</sup> or Terralin<sup>®</sup> (available at chemist's shops or drugstores).
- The rotational vacuum concentrator and the accessories consist of various materials. A possible incompatibility must be considered.
- Before using cleaning or decontamination agents that were not recommended by us, contact the manufacturer to ensure that such a procedure will not damage the rotational vacuum concentrator.
- For autoclaving, consider the continuous heat resistance of the individual materials.
- Please contact us if you have any queries (see chapter 8.4 - "Service").

## 8 Maintenance and service

### 8.3 Autoclaving

The service life of the accessories essentially depends on the frequency of autoclaving and use.

- Remove the existing O-rings so that the trapezoid notch can be reached by the hot steam. This prevents the formation of humidity in the notch..
- Replace the accessories immediately when the parts show changes in colour or structure or in the occurrence of leaks etc.

Accessories	Max. temp [°C]	Min. time [min]	Max. time [min]	Max. cycles
Glass tubes	134-138	3	40	-
Polycarbonate tubes	115-118	30	40	20
Polypropylene tubes	115-118	30	40	30
Teflon tubes	134-138	3	5	100
Aluminium rotors	134-138	3	20	-
Aluminium accessories	134-138	3	20	-

### 8.4 Service



**DANGER**

#### **Danger to life due to electric shock!**

In the event of service work that requires the removal of the panels, there is a risk of electric shock or mechanical injury. Only qualified specialist personnel is authorised to perform this service work.

The rotational vacuum concentrator is subject to high mechanical stress. In order to be able to withstand this high level of stress, high-quality components were used during the production of the rotational vacuum concentrators. Nevertheless, wear cannot be excluded and it may not be visible from the outside.

This is why we recommend having the rotational vacuum concentrator checked by the manufacturer during an inspection once per year in the operating state and once every three years in the dismantled state.

Information and appointments:

#### **In Germany:**

Contact

Martin Christ Gefriertrocknungsanlagen GmbH

An der Unteren Söse 50

37520 Osterode

Tel. +49 (0) 55 22 / 50 07-44 44

E-mail: support.lab@martinchrist.de

**Outside Germany:**

- Contact our agency in your country. All agencies are listed at [www.martinchrist.de](http://www.martinchrist.de) → [Sales Partners]



If you would like to utilise our service, please state the type of your RVC and its serial number.

## 8.5 Return of defective parts

Although we exercise great care during the production of our products, it may be necessary to return a unit or accessory to the manufacturer.

In order to ensure the quick and economical processing of returns of freeze-dryers, rotational vacuum concentrators, spare parts, or accessories, we require complete and extensive information concerning the process. Please fill in the following forms completely, sign them, enclose them with the return package, and send them together with the product to:

Martin Christ Gefriertrocknungsanlagen GmbH  
An der Unteren Söse 50  
37520 Osterode (Germany)

### 1. Declaration of decontamination

As a certified company and due to the legal regulations for the protection of our employees and of the environment, we are obliged to certify the harmlessness of all incoming goods. For this purpose, we require a declaration of decontamination.

- The form must be filled in completely and signed by authorised and specialised personnel only.
- Affix the original form in a clearly visible manner to the outside of the packaging.



We will return the unit if no declaration of decontamination is provided!

## 8 Maintenance and service

---

### 2. Form for the return of defective parts

This form is for the product-related data. They facilitate the assignment, and they enable the quick processing of the return. If several parts are returned together in one packaging, please enclose a separate problem description for every defective part.

- A detailed problem description is necessary in order to perform the repair quickly and economically.
- Upon request, we will prepare and submit to you a cost estimate prior to performing the repair. Please confirm such cost estimate within 14 days. If the cost estimate has still not been confirmed after 4 weeks, we will return the unit. Please note that you must bear the incurred costs.



The unit must be packaged in a transport-safe manner. Please use the original packaging, if at all possible.

If the product is dispatched to us in unsuitable packaging, you will be charged the cost for returning it to you in new packaging.

The forms can be downloaded online from  
[www.martinchrist.de](http://www.martinchrist.de) → [Service] → [Overhaul, repair and leak testing].

## **9 Disposal**

### **9.1 Disposal of the RVC**

Martin Christ Gefriertrocknungsanlagen GmbH is a registered manufacturer of electric and electronic devices that are solely intended for commercial use.

- Comply with all local rules and regulations.

### **9.2 Disposal of the packaging**

- Dispose of the packaging, after having separated the individual materials.
- Comply with all local rules and regulations.

## 10 Technical data

Manufacturer:	Martin Christ Gefriertrocknungsanlagen GmbH
Type:	<b>RVC 2-33 IR</b>
Order number:	101244

Performance data	
Temperature:	+30 °C to +80 °C
Speed:	1,750 rpm
Relative centrifugal force:	530 x g
Max. permissible imbalance:	50 g
Max. density of material at process start:	2 kg / dm <sup>3</sup>

Connection requirements	
Electrical connection:	1 x 230 V / 50/60 Hz
Protection class:	I
IP code:	11
Apparent power:	1.5 kVA
Nominal current:	2.5 A
Stop valve connection:	230 V, 50 Hz, 20 W max.
Pressure control valve connection:	230 V, 50 Hz, 20 W max.
Vacuum pump connection:	230 V, 50 Hz, 3,5 A max.

Physical data	
Dimension of the unit	
Height:	315 mm
Height with open lid:	715 mm
Width:	550 mm
Depth:	520 mm + 20 mm vacuum connection
Dimensions of the rotor chamber	
Inside diameter:	330 mm
Height, inside:	222 mm
Max. lid opening angle:	approx. 80°
Weight:	approx. 49 kg
Noise level according to DIN 45635:	49 dB (A)
EMC according to EN 55011:	Class B

**10 Technical data**

Equipment connections	
Vacuum connection:	Small flange connection DN25KF (ISO 28403, DIN 2861)
Aeration valve:	Hose nozzle, outside diameter 4.5mm max. (DN2.5) or with air filter
Micro injection valve:	Hose nozzle, outside diameter 4.5mm max. (DN2.5) or with air filter
Mains input:	IEC C13 connector
Stop valve:	IEC C14 connector
Pressure control valve:	IEC C14 connector
Vacuum pump:	IEC C14 connector
Vacuum sensor:	M8 plug-and-socket connector
Serial interface:	SUB D-9 RS232 / Remote

## 10.1 Ambient conditions

- Use in closed spaces
- Altitudes up to 2,000 m
- Ambient temperature between +5°C and +25°C
- Maximum relative humidity of 80%
- Mains voltage fluctuations of up to  $\pm 10\%$  of the rated voltage

## 10.2 Technical documentation

The technical documentation of this rotational vacuum concentrator (e.g. circuit diagrams and the safety data sheets of the manufacturers) are not attached to this operating manual.

You can order these documents from our service department (see chapter 7.2 - "Service contact").

## 11 Appendix

# 11 Appendix

## 11.1 Mathematical relations

The automatic processes in the "Programmer module" menu (see chapter 6.5.3.2 - "Program administration") are based on the following considerations:

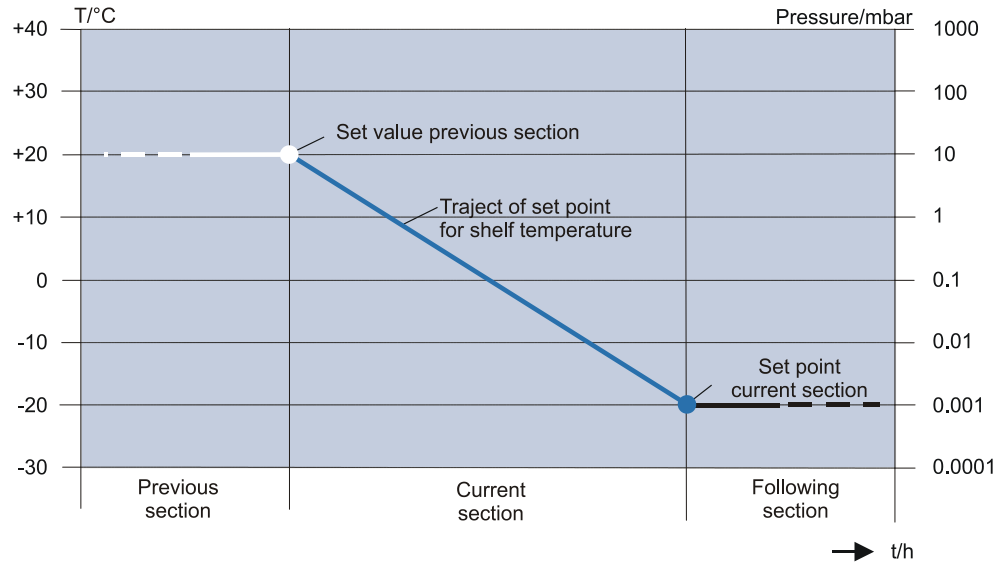

Fig. 71: Graphical representation of the course of the control setpoint

**Calculation of the control set value and of the gradient for the temperature:**

$$\text{gradient} = \frac{\text{set value of current section} - \text{set value of previous section}}{\text{section time of current section}} \quad [^{\circ}\text{C}/\text{min}]$$

$$\text{control set value} = \text{set value of previous section} + \text{elapsed section time} \cdot \text{gradient} \quad [^{\circ}\text{C}]$$

Example:

Section	Set values	
	Section time [h:min]	Temperature [°C]
Preceding	...	30
Current	1:00	60

$$\text{gradient} = \frac{60^{\circ}\text{C} - 30^{\circ}\text{C}}{60 \text{ min}} = \frac{30^{\circ}\text{C}}{60 \text{ min}} = 0.5^{\circ}\text{C}/\text{min}$$

After an elapsed section time of 30 minutes, for example, the control set value for the temperature is:

$$\text{Control set value}_{(t=30\text{min})} = 30^{\circ}\text{C} + 30 \text{ min} \cdot 0.5^{\circ}\text{C}/\text{min} = 45^{\circ}\text{C}$$

**Calculation of the control set value for the vacuum:**

$$\text{control set value} = 10^{\text{LOG10}(\text{set value prev. sect.}) + \left( \frac{\text{LOG10}(\text{set value current sect.}) - \text{LOG10}(\text{set value prev. sect.})}{\text{section time of current section}} \right) \cdot \text{elapsed section time}} \quad [\text{mbar}]$$



## 11.2 Rotor program

The actual rotor program can be downloaded from  
[www.martinchrist.de/Products/RVC](http://www.martinchrist.de/Products/RVC) → [unit type].

## 11 Appendix

### 11.3 Overview of evaporation times (RVC 2-33 CDplus with infrared heating)

	Vessel	Number of samples	Sample volume (ml)	Temperature (°C)	Pump	Cooling trap	Total time (min)
<b>Water</b>	100 ml test tube	12	50	30	RC 6	yes	625
	100 ml test tube	12	50	45	RC 6	yes	370
	100 ml test tube	12	50	60	RC 6	yes	285
	100 ml test tube	12	50	80	RC 6	yes	240
<b>Acetonitrile</b> C <sub>2</sub> H <sub>3</sub> N	100 ml test tube	12	50	30	RC 6	yes	112
	100 ml test tube	12	50	45	RC 6	yes	90
	100 ml test tube	12	50	60	RC 6	yes	75
	100 ml test tube	12	50	80	RC 6	yes	75
<b>1,4 Dioxane</b> C <sub>4</sub> H <sub>8</sub> O <sub>2</sub>	100 ml test tube	12	50	30	RC 6	yes	150
	100 ml test tube	12	50	45	RC 6	yes	85
	100 ml test tube	12	50	60	RC 6	yes	80
	100 ml test tube	12	50	80	RC 6	yes	60
<b>DMSO</b> C <sub>2</sub> H <sub>6</sub> OS	100 ml test tube	12	50	45	RC 6	yes	320
<b>Toluol</b> C <sub>6</sub> H <sub>5</sub> CH <sub>3</sub>	100 ml test tube	12	50	30	RC 6	yes	105
	100 ml test tube	12	50	45	RC 6	yes	70
	100 ml test tube	12	50	60	RC 6	yes	65
	100 ml test tube	12	50	80	RC 6	yes	50
<b>Ethanol</b> C <sub>2</sub> H <sub>6</sub> O	100 ml test tube	12	50	30	RC 6	yes	130
	100 ml test tube	12	50	45	RC 6	yes	95
	100 ml test tube	12	50	60	RC 6	yes	85
	100 ml test tube	12	50	80	RC 6	yes	85

**11 Appendix**

	Vessel	Number of samples	Sample volume (ml)	Temperature (°C)	Pump	Cooling trap	Total time (min)
<b>Methanol</b>	100 ml test tube	12	50	30	RC 6	yes	130
CH <sub>3</sub> OH	100 ml test tube	12	50	45	RC 6	yes	105
	100 ml test tube	12	50	60	RC 6	yes	90
	100 ml test tube	12	50	80	RC 6	yes	75
<b>n-Hexan</b>	100 ml test tube	12	50	30	RC 6	yes	30
C <sub>6</sub> H <sub>14</sub>	100 ml test tube	12	50	45	RC 6	yes	28
	100 ml test tube	12	50	60	RC 6	yes	25

## 11 Appendix

---

### 11.4 Brief operating instructions

1. Switch on the system at the mains power switch down on the right side of the unit.
2. Switch on the cooling trap and/or the vacuum pump.
3. Close the lid.
4. Starting the warm-up phase:
  - Enter the set values for the warm-up phase into "menu" – "options" – "Timer warm-up" und "Temperature warm-up", confirm your entries and quit the menu.
  - Press the left-hand function key "mode".
  - Select the "Warm-up" menu and confirm.
  - Open the lid when the warm up phase has ended.
  - Install the rotors and close the lid.
5. Changing the set values for time, temperature, vacuum and safety pressure:
  - Select "menu" with the right-hand function key.
  - Select "Change set values for manual mode" from the main menu.
  - Select the set value by using the up/down keys and confirm with the right-hand function key "edit".
  - Change the set value by using the up/down keys and confirm with the right-hand function key "ok".
  - Quit the menu with the left-hand function key.
6. Starting the process "Evaporation manual" or "Evaporation program":
  - Open the menu "Start with phase..." by pressing the left-hand function key "mode".
  - Select "Evaporation manual" or "Evaporation program" using the up/down keys.
  - Start the evaporation process by pressing the right-hand function key.
  - The function "Evaporation program" can only be selected if a program has been created before.
  - The start of the evaporation process starts the following automatic process run:
    - The rotor speed increases (rotating direction left),
    - At 70% of the selected maximum speed: the aeration valve closes automatically (to avoid delays in boiling),
    - At 80% of the selected maximum speed: the stop valve opens the connection to the vacuum pump,
    - Further speed increase until the preselected maximum rotor speed is reached.
7. Interrupting an evaporation process:
  - Press the left-hand function key "mode".
  - Select "Stop evaporation" and confirm.

Without an interruption, the evaporation process ends after the preselected time. The following process runs automatically:

  - At maximum speed: the stop valve closes the connection to the vacuum pump, the aeration valve opens; the rotor speed is maintained for 30 sec (aeration phase, to avoid delays in boiling).

- Rotor decelerates until it is at a standstill. After the standstill of the rotor the lid can be opened in order to remove the rotors.

**Functional and operating elements**

- 1 Lid
- 2 Rotor chamber
- 3 Control panel  
<dg\_ref\_source\_inline>-Bedienoberfläche-</dg\_ref\_source\_inline>
- 4 Lid lock device
- 5 Rotor shaft
- 6 Mains power switch
- 7 Electrical vacuum sensor connection
- 8 Option: Serial Interface RS 232
- 9 Option: Serial Interface Remote
- 10 Valve block  
<dg\_ref\_source\_inline>Valve block -</dg\_ref\_source\_inline>
- 11 Power supply connection of the vacuum pump
- 12 Power supply connection of the pressure control valve
- 13 Name plate  
<dg\_ref\_source\_inline>-Name plate-</dg\_ref\_source\_inline>
- 14 Vacuum connection
- 15 Equipotential bonding screw
- 16 Mains connection and mains fuse protection
- 17 Power supply connection of the stop valve



Fig. 72: Total view of the RVC



Fig. 73: Rear view of the RVC

## 11 Appendix

---

## 11.5 EC declaration of conformity



### **EC – DECLARATION OF CONFORMITY**

**in accordance with the EC Machinery Directive 2006/42/EC, annex II, part 1, section A**

The product named hereinafter was developed, designed, and manufactured in compliance with the relevant, fundamental safety and health requirements of the listed EC directives.

In the event of modifications that were not authorised by us or if the product is used in a manner that is not in line with the intended purpose, this declaration will be rendered void.

<i>Product name:</i>	Rotational Vacuum Concentrator
<i>Product type:</i>	RVC 2-33 CDplus with infrared heating
<i>Order number:</i>	101244
<i>Directives:</i>	2006/42/EG Machinery Directive 2014/35/EU Low Voltage Directive 2014/30/EU EMC Directive

**Martin Christ Gefriertrocknungsanlagen GmbH**

An der Unteren Söse 50  
 37520 Osterode  
 Germany

Authorised representative  
 for CE matters:  
 S. Krippendorff

Osterode, 18/02/2016



M. Christ, Management

## 11 Appendix

---



## 11.6 Declaration of conformity – China RoHS 2



### DECLARATION OF CONFORMITY

#### China RoHS 2 (Administrative Measures for the Restriction of the Use of Hazardous Substances in Electrical and Electronic Products)

Freeze-dryer models: Alpha 1-2 LDplus, Alpha 1-4 LSCbasic, Alpha 2-4 LSCbasic, Alpha 3-4 LSCbasic, Alpha 1-4 LSCplus, Alpha 2-4 LSCplus, Beta 1-8 LSCbasic, Beta 2-8 LSCbasic, Beta 1-8 LSCplus, Beta 2-8 LSCplus, Gamma 1-16 LSCplus, Gamma 2-16LSCplus, Delta 1-24 LSCplus, Delta 2-24 LSCplus

Rotational Vacuum Concentrator models: RVC 2-18 CDplus, RVC 2-18 CDplus HCl-resistant, RVC 2-25 CDplus, RVC 2-33 CDplus, RVC 2-33 CDplus with infrared heating

Cooling trap models: CT 02-50 SR, CT 04-50 SR

Cooling bath model: CB 18-40

Christ Gefrier Trocknungsanlagen GmbH has made reasonable effort to avoid the use of hazardous substances in the products (freeze-dryers and RVC).

A Product Conformity Assessment (PCA) was performed in order to determine whether the concentration of harmful substances in all homogeneous materials of the component parts is above or below the MCV limit (Maximum Concentration Value limit) as defined in GB/T 26572:

Mercury and its compounds: 0.1 %      Cadmium (Cd) and its compounds: 0.01 %  
 Lead (Pb) and its compounds: 0.1 %      Hexavalent chromium (Cr (VI)) and its compounds: 0.1 %  
 Polybrominated biphenyls (PBB): 0.1 %      Polybrominated diphenyl ethers (PBDE): 0.1 %

表1 产品中有害物质的名称及含量  
 Table 1: Name and content of hazardous substances in the product

部件名称 Component part (PCA)	有害物质 Hazardous substance					
	铅 Lead (Pb)	汞 Mercury (Hg)	镉 Cadmium (Cd)	六价铬 Hexavalent Chromium (Cr (VI))	多溴联苯 Poly-brominated biphenyls (PBB)	多溴二苯醚 Polybrominated diphenyl ethers (PBDE)
Electronic PCB, cables	X <sup>1)</sup>	○	○	○	○	○
Display	○	○	○	○	○	○
Housing	X <sup>2)</sup>	○	○	○	○	○
Base, metal, accessories	X <sup>2)</sup>	○	○	○	○	○

本表格依据SJ/T 11364的规定编制。  
 This table is made according to SJ/T 11364.

## 11 Appendix



O: 表示该有害物质在该部件所有均质材料中的含量均在GB/T 26572规定的限量要求以下。  
Indicates that the content of the harmful substance in all homogeneous materials of the component part is below the limit as defined in GB/T 26572.)

X: 表示该有害物质至少在该部件的某一均质材料中的含量超出GB/T 26572规定的限量要求。(企业可在此处, 根据实际情况对上表打“X”的技术原因进行进一步说明。)  
Indicates that the content of the harmful substance in at least one homogeneous material of the component part exceeds the limit as defined in GB/T 26572. (Contact the manufacturer for further technical information according to the actual situation.)

1) Contains parts in compliance with exemptions 6c, 7c.I, 7c.II and 37 of 2011/65/EU RoHS.

2) Contains parts in compliance with exemptions 6a, 6b and 6c of 2011/65/EU RoHS.

Apart from the exemptions given in this table, none of the substances listed above have been intentionally added to the product or metallic coatings.

### **Martin Christ Gefriertrocknungsanlagen GmbH**

An der Unteren Söse 50  
37520 Osterode  
Germany

Osterode, 25/11/2021



F. Harms, Management

## 12 Glossary

### **Boiling retardation**

The temperature of a liquid can rise above the boiling point without the liquid actually starting to boil. Vibrations or shocks quickly lead to the formation of a large gas bubble that escapes explosively from the vessel. This phenomenon is known as boiling retardation. It occurs when neither the liquid nor the wall of the vessel include any condensation nuclei at which vapour bubbles might form.

### **Pressure increase test**

The pressure increase test is used to determine whether the evaporation in the rotor chamber is complete. During the pressure increase test, the rotor chamber is separated from the cooling trap or vacuum pump by way of the stop valve. The system evaluates the pressure increase that is caused by any additionally released steam.

In order to perform the pressure increase test, limits for the pressure increase as well as the test duration must be defined beforehand.

### **Relative centrifugal force**

The relative centrifugal force is the acceleration that the samples are subjected to during the rotation. The acceleration is stated as a multiple of the mean gravitational acceleration  $g$ . It can be increased by increasing the radius inside the rotor chamber and by increasing the speed. These three parameters are interdependent and linked with each other via the following formula:

$$\text{Relative centrifugal force } RCF = 11.18 \times 10^{-6} \times r \times n^2$$

*r = radius in cm*

*n = speed in rpm*

*RCF without any dimension*

## 12 Glossary

### Safety pressure

Since the vacuum has a dominating influence on the product temperature, Martin Christ Gefriertrocknungsanlagen GmbH has integrated a so-called safety pressure function into their units in order to protect the products. If the pressure inside the rotor chamber rises too quickly – above the safety limit – the energy supply of the unit will be interrupted so that the evaporation process slows down.

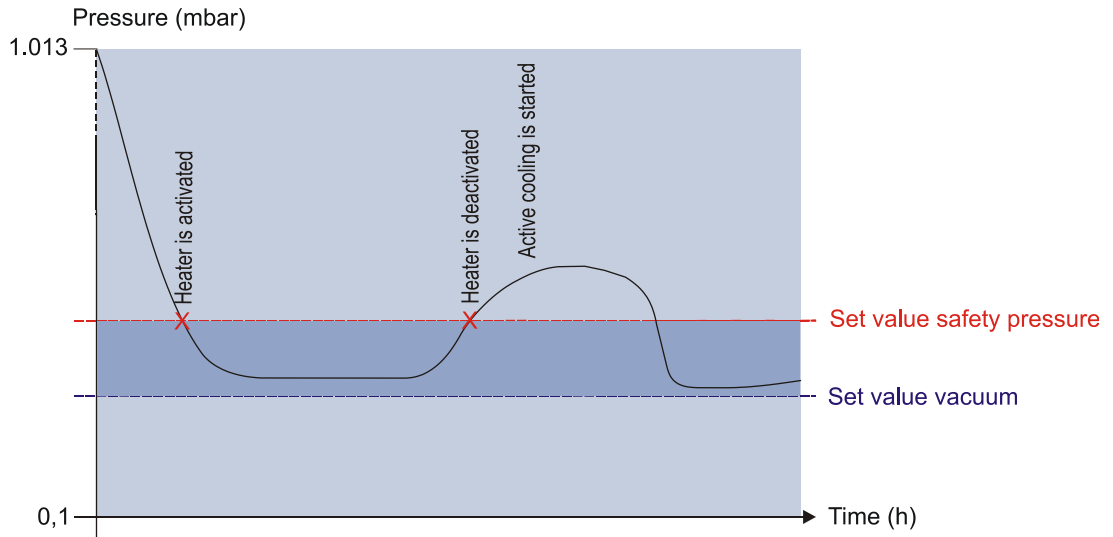

Fig. 74: Diagram describing the safety pressure function

## 13 Index

<b>A</b>	
Accessories .....	12, 32
Accessories, cleaning and care.....	80
Accident prevention .....	21
Accidents .....	29
Acids.....	30
Active phases .....	50
Advantages of the rotational vacuum concentration.....	16
Aeration valve.....	87
Aluminium accessories .....	82
Aluminium accessories, cleaning and care.	80
Aluminium rotor.....	82
Ambient conditions.....	87
Ambient temperature .....	87
Apparent power .....	14, 86
Assignment of the function keys.....	49
Autoclaving .....	82
<b>B</b>	
Boiling retardation.....	99
Brief operating instructions.....	92
Bucket.....	46
Burns .....	29
<b>C</b>	
Calculation of the control set value and of the gradient for the temperature .....	88
Calculation of the control set value for the vacuum .....	88
Care of the accessories .....	80
CDplus configuration.....	62
CDplus control system .....	48
CE-Zeichen gemäß Richtlinie 2006/42/EG.	17
Chamber overtemperature .....	63
Change display contrast.....	60
Changing the set values for the manual mode .....	53
Chemical burns.....	29
China RoHS 2 – Declaration of conformity.	97
Circuit diagrams.....	87
Cleaning .....	30
Cleaning agents.....	74
Cleaning of the rotational vacuum concentrator .....	75
Cleaning the rotor chamber.....	76
Cleaning the RVC and the accessories.....	74
Click at button push .....	61
Closing the lid .....	42
Commissioning .....	12
compatibility test .....	19
Condensate, contaminated (hazards) .....	26
Condensation of the vapours upstream of the vacuum pump in a cooling trap.....	40
Connection.....	31
Connection (hazards).....	23
Connection for aeration and air injection with inert gas .....	37
Connection for aeration with ambient air and air injection with inert gas .....	36
Connection of a vacuum pump and/or a cooling trap.....	39
Connection requirements .....	86
Contaminated condensate (hazards) .....	26
Contaminated defrosting water (hazards) ..	26
Continuous operation coldtrap .....	61
Continuous operation vacuum pump.....	61
Copying a program .....	57
Copyright .....	12
Corrosion .....	45, 74, 76, 80
Cost estimate.....	84
Cracks .....	80
Creating a new program.....	56
Customer-provided fuses .....	35
<b>D</b>	
Danger (Electricity) .....	24
Danger (Surfaces, hot).....	25
Dangerous goods.....	26
Dangerous materials.....	81
Declaration of conformity .....	95
Declaration of conformity – China RoHS 2.	97
Declaration of decontamination.....	83
Defrosting water, contaminated (hazards)..	26
Deleting a program .....	57
Dimensions .....	33

## Index

Dimensions of the rotor chamber .....	86	<b>G</b>	
Dimensions of the unit .....	86	General conditions .....	11
Direct hazard to the life and health.....	18	General malfunctions .....	63
Disinfection of the rotor chamber and accessories .....	81	General work (maintenance) .....	74
Display .....	49	Glass breakage.....	81
Disposal of the packaging .....	85	Glass tubes.....	82
Disposal of the RVC.....	85	<b>H</b>	
Drying of solvent-containing products .....	20	Handling of hazardous substances .....	32
<b>E</b>		Hazard warnings.....	9, 11, 42
Earth conductor check .....	28	Hazardous substances .....	23
EC-Declaration of conformity .....	95	Hazardous substances, handling .....	32
Editing a program.....	56	Hazards .....	29
Electrical connection .....	86	Hazards (connection) .....	23
Electricity (Danger) .....	24	Hazards (contaminated condensate).....	26
EMC according to EN 55011.....	86	Hazards (contaminated defrosting water)...	26
Emergency.....	29	Hazards (Explosive substances).....	25
Emissions .....	27	Hazards (Flammable substances).....	25
Equipment connection .....	87	Hazards (general, transport to commissioning) .....	22
Equipotential bonding screw .....	28, 35	Hazards (products, harmful).....	27
Error correction .....	63	Hazards (products, harmful).....	25, 75
Error messages .....	28, 63	Hazards (set-up) .....	22
Evaporation of solvent-containing products.... .....	9, 11	Hazards (surfaces, hot).....	75
Evaporation with different tube sizes.....	44	Hazards (transport) .....	22
Evaporation with low capacity .....	45	Hazards, evaporation.....	27
Evaporation, harmful (Hazards) .....	27	Health, safety and accident prevention regulations.....	19
Examples of use .....	16	High temperature resolution.....	61
Explanation of symbols .....	12	Humidity.....	87
Explanation of the symbols and notes.....	18	<b>I</b>	
Explosive substances .....	25	Ice condenser temperature not reached.....	64
Explosive substances (Hazards).....	25	Imbalance .....	26, 43
Extended service menu.....	62	Importance of the operating manual.....	9
<b>F</b>		Important information .....	18
Factory settings loaded.....	64	infectious substances.....	27
Fire .....	29	Informal safety instructions .....	21
Fire protection.....	31	Information status .....	59
Flammable substances .....	25	Initial start-up .....	42
Flammable substances (Hazards).....	25	Injuries .....	29
Form for the return of defective parts .....	84	Installation direction of the pressure control valve.....	38
Function keys.....	48	Installation of accessories .....	44
Functional elements.....	13	Installation of angle rotors .....	43
Fuses, customer-provided.....	35	Installation of rotors and accessories .....	43
		Installation of swing-out rotors.....	44

Installation site .....	35	Nominal rotor speed not reached .....	64
Intended use .....	9	Nominal voltage .....	14
IO communication error.....	65	Notes on safety and hazards .....	9
IP code .....	86	<b>O</b>	
<b>L</b>		On-site transport .....	34
Layout of the RVC.....	13	Opening the lid.....	42, 51
Lid cannot be opened .....	63	Operating elements.....	13
Lid contacts error .....	63	Operating mode .....	50
Lid lock device .....	28	Operating personnel .....	21
Lid status .....	50	Operating voltage.....	35
Load default settings.....	62	Option: Pressure control valve and vacuum sensor .....	38
Lyes .....	30	Option: Remote control of the cooling trap via RVC .....	41
<b>M</b>		Options .....	60
Main menu .....	53	Order number .....	86
Mains input .....	87	Overview of evaporation times (RVC 2-33 CDplus with infrared heating) .....	90
Mains power failure.....	64	<b>P</b>	
Mains power switch.....	42	Packaging .....	33
Mains voltage.....	87	Packaging, disposal .....	85
Maintenance .....	30, 74	Part number .....	14
Maintenance (general work).....	74	pathogenic substances .....	27
Maintenance and service .....	74	Pathogenic substances.....	75
Malfunctions.....	63	Pending information .....	50
Manual evaporation .....	52	Performance data .....	86
Manufacturer.....	26, 27, 74, 85, 86	Permissible imbalance exceeded.....	64
Marking of the unit .....	17	Physical data .....	86
Mathematical relations .....	88	Pivotal point .....	46, 47
Max. density of material at process start ....	86	Polycarbonate tubes .....	82
Max. humidity.....	87	Polypropylene tubes .....	82
Max. lid opening angle .....	86	Potential hazard to the life and health .....	18
Max. permissible imbalance.....	86	Potentially hazardous situation.....	18
Maximum current for the vacuum pump .....	39	Power failure safety .....	28
Measures for safe operation .....	31	Power supply .....	35
Micro injection valve.....	87	Pressure control valve .....	38, 87
Mode.....	51	Pressure control valve connection .....	86
Mode of operation.....	15	Pressure increase test .....	58, 99
<b>N</b>		Pressure marks.....	80
Name plate .....	14	Prevention of accidents.....	9, 21
No ice condenser sensor signal .....	63	Principle of the rotational vacuum concentration.....	15
No rotor chamber sensor signal .....	63	Process and equipment information.....	59
No rotor detected (only Triple TMM).....	64	Process messages.....	64
No rotor sensor signal.....	63	Products, harmful (hazards).....	25, 75
No vacuum sensor signal.....	63		
Noise level according to DIN 45635 .....	86		
Nominal current .....	86		

## Index

Products, harmful (Hazards) .....	27	Safety notes concerning the transport .....	22
Products, solvent-containing .....	11	Safety pressure .....	54, 100
Program administration .....	55	Safety pressure not reached .....	64
Program memory information .....	58	Safety range .....	23, 31
Program-controlled evaporation .....	52	Scope of supply .....	12
Protection class .....	35, 86	Select language .....	60
Protection of the environment .....	21	Serial interface .....	87
protective clothing .....	27	Serial number .....	14, 73, 83
<b>Q</b>		Service .....	82
Qualified electrician .....	20	Service contact .....	73
<b>R</b>		Service life .....	74, 80
radioactive substances .....	27	Service life of the accessories .....	82
Radioactive substances .....	75	Service menu .....	61
Rated current .....	14	Settings .....	60
Regulations concerning health, safety and accident prevention .....	19	Set-up .....	31
Relative centrifugal force .....	86	Set-up (hazards) .....	22
Remaining hazards .....	32	Set-up and connection .....	35
Remote control of the cooling trap via RVC	41	Signs of corrosion .....	80
Remove the glass particles and the metal dust from the rotor chamber .....	81	Small flange connections .....	72
Requirements concerning the personnel .....	20	Solvent .....	30
Responsibility of the operator .....	19	Solvent-containing products .....	9, 11
Return of defective parts .....	83	Solvents .....	74
Risk assessment .....	19	Special functions .....	58
risk of burns .....	25	Specialised personnel .....	21
Risk of burns .....	51	Specialist personnel .....	82
Rotational vacuum concentrator, cleaning and care .....	75	Speed .....	86
Rotor blocks .....	46	Standards and regulations .....	12
Rotor chamber, cleaning .....	76	Status bar .....	50
Rotor overtemperature .....	63	Stop valve .....	87
Rotor speed .....	61	Stop valve connection .....	86
<b>S</b>		Stopping the evaporation process prematurely .....	52
Safe operation (measures) .....	31	Stopping the warm-up phase prematurely ..	52
Safety area .....	26	Storage and transport .....	33
Safety data sheets .....	87	Storage conditions .....	33
Safety devices .....	28	Stress-corrosion .....	80
Safety distance .....	26, 35	Supply voltage .....	23, 35
Safety instructions .....	9, 11, 42	Surface temperature .....	51
Safety instructions for evaporation .....	26	Surface temperatures .....	25
Safety notes concerning set-up and connection .....	22	Surfaces, hot (Danger) .....	25
Safety notes concerning the initial start-up.	22	Surfaces, hot (hazards) .....	75
Safety notes concerning the operation .....	23	Susceptibility to corrosion .....	80
		Switching the RVC on .....	42
		System check .....	28
		System messages .....	65



---

<b>T</b>			
Technical data .....	86		
Technical documentation .....	87		
Teflon tubes .....	82		
Temperature .....	54, 86		
Temperature Warm-up.....	61		
Thermal stress .....	35, 74		
Timer Evaporation.....	54		
Timer Heating .....	54		
Timer Warm-up.....	61		
toxic substances .....	27		
Toxic substances .....	75		
Transport (hazards) .....	22		
Transport safety devices .....	34		
Transport to commissioning (hazards, general) .....	22		
Tubes.....	45		
Type.....	14, 86		
Type of connection.....	35		
Type of the RVC .....	83		
<b>U</b>			
Units of protection class I .....	35		
		Up and down keys .....	48
		User interface .....	48
		UV radiation .....	35, 74
		<b>V</b>	
		Vacuum .....	54
		Vacuum connection .....	37, 87
		Vacuum pump.....	87
		Vacuum pump connection.....	86
		Vacuum sensor.....	38, 87
		Values window .....	49
		Vapour pressure curve for ice and water....	15
		Ventilation .....	35
		Visible damage of the surface .....	80
		VSK3000 calibration error .....	64
		<b>W</b>	
		Warranty and liability.....	11
		Weight .....	33, 86
		Withdrawal of the vapours by a vacuum pump .....	39
		<b>Y</b>	
		Year of manufacture .....	14